

Instructions

Multispectrum IR Flame Detector
Model X3302



Table of Contents

| | | | |
|--|----|--|----|
| DESCRIPTION | 1 | FEATURES | 15 |
| Outputs | 2 | SPECIFICATIONS | 16 |
| LED | 2 | REPLACEMENT PARTS | 17 |
| oi (Optical Integrity) | 2 | DEVICE REPAIR AND RETURN | 17 |
| Communication | 3 | ORDERING INFORMATION | 18 |
| Data Logging | 3 | Accessories | 18 |
| Integral Wiring Compartment | 3 | X3302 Model Matrix | 19 |
| Detector Sensitivity Levels | 3 | APPENDIX A – FM APPROVAL AND PERFORMANCE REPORT | 24 |
| GENERAL APPLICATION INFORMATION | 4 | APPENDIX B – CSA APPROVAL | 31 |
| Response Characteristics | 4 | APPENDIX C – ATEX APPROVAL | 32 |
| Important Application Considerations | 4 | APPENDIX D – IECEx APPROVAL | 34 |
| IMPORTANT SAFETY NOTES | 5 | APPENDIX E – EN54 APPROVALS | 35 |
| INSTALLATION | 5 | APPENDIX F – ADDITIONAL APPROVALS | 36 |
| Detector Positioning | 5 | APPENDIX G – DECLARATION OF CONFORMITY | 37 |
| Detector Orientation | 6 | | |
| Protection Against Moisture Damage | 6 | | |
| Wiring Procedure | 6 | | |
| Setting Device Network Addresses (EQP Model Only) | 12 | | |
| STARTUP PROCEDURE | 13 | | |
| Fire Alarm Test | 13 | | |
| TROUBLESHOOTING | 13 | | |
| MAINTENANCE | 14 | | |
| Cleaning Procedure | 14 | | |
| oi Reflector Plate Removal and Replacement | 14 | | |
| Periodic Checkout Procedure | 15 | | |
| Clock Battery | 15 | | |

**Multispectrum IR Flame Detector
Model X3302****IMPORTANT**

Be sure to read and understand the entire instruction manual before installing or operating the flame detection system. Any deviation from the recommendations in this manual may impair system performance and compromise safety.

ATTENTION

*The X3302 includes the Automatic oi[®] (Optical Integrity) feature — a calibrated performance test that is automatically performed once per minute to verify complete detector operation capabilities. **Testing with an external test lamp is not approved or required.***

DESCRIPTION

The X3302 brings state-of-the-art IR flame detection to the difficult task of detecting invisible hydrogen flames. Focusing on the water-band IR emissions of hydrogen and hydrocarbon flames, the X3302 overcomes the limited detection range and false alarm tendencies of other flame detectors by employing field proven multispectrum infrared (MIR) technology. The result is unsurpassed flame sensitivity with discrimination of non-flame sources in situations where traditional flame detectors are unsuitable.

Utilizing the X3301's multi-patented signal processing algorithms, the X3302 provides a breakthrough in flame detection/surveillance of hazardous materials that produce mostly water vapor, and little or no Carbon Dioxide (CO₂) in the combustion process. The detection capability of the X3302 is double that of traditional UV and UVIR detectors. At the same time, it attains solar resistance and insensitivity to artificial lights, lightning, and "blackbody" radiation, which still plague other detection technologies.

The detector has Division and Zone explosion-proof ratings and is suitable for use in indoor and outdoor applications.



The standard output configuration includes fire, fault and auxiliary relays. Output options include:

- 0–20 mA output (in addition to the three relays)
- Pulse output for compatibility with existing Detector Electronics Corporation (Det-Tronics) controller based systems (with fire and fault relays)
- Eagle Quantum Premier[®] (EQP) compatible model (no analog or relay outputs)
- HART communication

A tri-color LED on the detector faceplate indicates normal condition and notifies personnel of fire alarm or fault conditions.

Microprocessor controlled heated optics increase resistance to moisture and ice.

The X3302 housing is available in copper-free aluminum or stainless steel, with Type 4X and IP66/IP67 rating.

OUTPUTS

Relays

The standard detector is furnished with fire, fault and auxiliary relays. All three relays are rated 5 amperes at 30 Vdc.

The Fire Alarm relay has redundant terminals and normally open / normally closed contacts, normally de-energized operation, and latching or non-latching operation.

The Fault relay has redundant terminals and normally open contacts, normally energized operation, and latching or non-latching operation.

The Auxiliary relay has normally open / normally closed contacts, and is configurable for energized or de-energized operation, and latching or non-latching operation.

0–20 mA Output

A 0–20 mA output is available as an option (in addition to the three relays). This option provides a 0–20 mA dc current output for transmitting detector status information to other devices. The circuit can be wired in either an isolated or non-isolated configuration and can drive a maximum loop resistance of 500 ohms from 18 to 19.9 Vdc and 600 ohms from 20 to 30 Vdc. Table 1 indicates the detector status conditions represented by the various current levels. The output is calibrated at the factory, with no need for field calibration. A model with relays and 0–20 mA with HART is also available. Refer to Addendum number 95-8613 for complete details.

NOTE

The output of the 0–20 mA current loop is not monitored by the fault detection circuitry of the X3302. Therefore, an open circuit on the loop will not cause the fault relay to change state or the detector status LED to indicate a fault. The status of the LED always follows the status of the relays.

Table 1—Detector Status Conditions Indicated by Current Level

| Current Level (± 0.3 mA) | Detector Status |
|-------------------------------|--------------------------|
| 0 mA | Power Fault |
| 1 mA | General Fault |
| 2 mA | oi Fault |
| 3 mA | High Background IR Fault |
| 4 mA | Normal Operation |
| 20 mA | Fire Alarm |

An alarm condition will normally over-ride a fault condition, unless the nature of the fault condition impairs the ability of the detector to generate or maintain an alarm output, i.e., loss of operating power.

LON/SLC Output

The EQP model is designed for use exclusively with the Det-Tronics Eagle Quantum Premier® system. The detector communicates with the system controller over a digital communication network or LON/SLC (Local Operating Network/ Signaling Line Circuit). The LON/SLC is a fault tolerant, two wire digital communication network arranged in a loop configuration. Analog and relay outputs are not available on this model.

LED

A tri-color LED on the detector faceplate indicates normal condition and notifies personnel of fire alarm or fault conditions. Table 2 indicates the condition of the LED for each status.

Table 2—Detector Status Indicator

| Detector Status | LED Indicator |
|---|---|
| Power On/Normal Operation (no fault or fire alarm) | Green |
| Fault | Yellow |
| Fire (Alarm) | Red |
| Low Sensitivity | One Yellow Flash During Power-up |
| Medium Sensitivity | Two Yellow Flashes During Power-up |
| High Sensitivity | Three Yellow Flashes During Power-up |
| Very High Sensitivity | Four Yellow Flashes During Power-up |

NOTE

See "Detector Sensitivity Levels" for additional information.

oi (OPTICAL INTEGRITY)

Automatic oi

The X3302 includes the Automatic **oi** feature — a calibrated performance test that is automatically performed once per minute to verify complete detector operation capabilities. No testing with an external test lamp is required. The detector automatically performs the same test that a maintenance person with a test lamp would perform — once every minute. However, a successful Automatic **oi** test does not produce an alarm condition.

The X3302 signals a fault condition when less than half of the detection range remains. This is indicated by the Fault output and is evident by the yellow color of the LED on the face of the detector. The **oj** fault condition is self-clearing if the optical contamination is temporary. If the contamination is not automatically cleared and the **oj** fault remains, the detector may require cleaning or service. See the "Troubleshooting" section for further information.

Magnetic **oj** / Manual **oj**

The detector also incorporates both Magnetic **oj** (Mag **oj**) and Manual **oj** (Man **oj**) features that provide the same calibrated test as the Automatic **oj**, and in addition actuates the Alarm output to verify operation for preventive maintenance requirements. These features can be performed at any time and eliminate the need for testing with a non-calibrated external test lamp.



CAUTION

These tests require disabling of all extinguishing devices to avoid release resulting from a successful test.

The Mag **oj** test is performed by placing a magnet at the location marked "MAG OI" on the outside of the detector (see Figure 2). The Man **oj** test is accomplished by connecting the **oj** lead (terminal 22) to power supply minus via an external switch. The magnet or switch must be held in place for a minimum of 6 seconds to complete the test. Either of these test methods activates the calibrated IR emitters. If the resulting signal meets the test criteria, indicating that greater than half of the detection range remains, the fire alarm output of the detector is activated. On all models other than the EQP, this condition remains until the magnet is removed or the switch is released, regardless of whether the relays are set for latching or non-latching operation. On model EQP, the condition remains for four seconds.

If less than half of the detection range remains, no alarm is produced and a fault is generated. The fault indication can be reset by momentarily applying the Mag **oj** or Man **oj** switch. In this case, the detector's optics should be cleaned and the **oj** test should be repeated. See the "Cleaning Procedure" section of this manual for details.

NOTE

*Refer to Appendix A for FM verification of the **oj** function.*

COMMUNICATION

The X3302 is furnished with an RS-485 interface

for communicating status and other information with external devices. The RS-485 supports Modbus protocol, with the detector configured as a slave device.

For HART communication, connect a HART communicator across a 250 ohm resistor in the 0–20 mA loop.

NOTE

HART equipped X3302 are not available with RS-485 communication.

DATA LOGGING

Data logging capability is also provided. Status conditions such as normal, power down, general and **oj** faults, fire alarm, time and temperature are recorded. Each event is time and date stamped, along with the temperature and input voltage. Event data is stored in non-volatile memory when the event becomes active, and again when the status changes. Data is accessible using the Inspector Connector accessory, RS-485, or the EQP Controller.

INTEGRAL WIRING COMPARTMENT

All external wiring to the device is connected within the terminal compartment. The detector is furnished with four conduit entries, with either 3/4 inch NPT or M25 threads.

DETECTOR SENSITIVITY LEVELS

There are four factory configured sensitivity levels available for the X3302 Flame Detector:

Very High, High, Medium, and Low.

The following criteria should be considered when choosing a sensitivity level for the intended application:

- Detector placement
- Speed of response based on fuel type and fire size (see Appendix A for response times)
- Distance between the hazard and the flame detector

Additional information on X3302 Flame Detector performance results and sensitivities can be found in Appendix A, the FM Approval and Performance Report.

SUSTAINED FIRE MODE

Sustained Fire Mode is an optional software configuration that provides an increased verification time to a sustained fire. The algorithm has been optimized to provide a longer processing time to fires while maintaining detection range. Consult the factory with any questions on how to choose the optimum sensitivity level for the intended application.

GENERAL APPLICATION INFORMATION

RESPONSE CHARACTERISTICS

Response is dependent on the detector's sensitivity setting, distance, type of fuel, temperature of the fuel, and time required for the fire to come to equilibrium. As with all fire tests, results must be interpreted according to an individual application.

See Appendix A for third-party approved fire test results. Additional fire test results are available from Det-Tronics

IMPORTANT APPLICATION CONSIDERATIONS

In applying any type of sensing device as a fire detector, it is important to know of any conditions that can prevent the device from responding to fire, and also to know what other sources besides fire can cause the device to respond.

Welding

It is recommended that the system be bypassed during welding operations in situations where the possibility of a false alarm cannot be tolerated. Gas welding mandates system bypass, since the gas torch is an actual fire. Arc welding rods can contain organic binder materials in the flux that burn during the welding operation and are detectable by the X3302. Welding rods with clay binders do not burn and will not be detected by the X3302. However, system bypass is always recommended, since the material being welded may be contaminated with organic substances (paint, oil, etc.) that will burn and possibly cause the X3302 to alarm. Due to the possibility of an alarm condition, arc welding should not be performed within 40 feet (12.2 m) of the detector configured to very high sensitivity, within 35 feet (10.7 m) at high sensitivity, within 25 feet (7.6) at medium sensitivity and within 15 feet (4.6 m) at low sensitivity.

Artificial Lighting

The X3302 should not be located within 2 feet (0.6 m) of artificial lights. Excess heating of the detector could occur due to heat radiating from the lights.

EMI/RFI Interference

The X3302 is resistant to interference by EMI and RFI, and is EMC Directive compliant. It will not respond to a 5 watt walkie-talkie at distances greater than 1 foot (0.3 m). Do not operate a walkie-talkie within 1 foot (0.3 m) of the X3302.

Carbon Containing Fires

The X3302 is a multiple spectrum IR device with detection limited to flames that produce water vapor as a by-product of combustion. These include hydrogen, ammonia, arsine, silane, and light hydrocarbons such as methane and methanol. Some lighter carbonaceous fuels may be detectable by the X3302, but heavier carbon containing substances that burn with a dark yellow-orange flame and emit dense sooty smoke may not be sensed with this device. Other fuels that are not detectable include sulfur and burning metals. Fuels that contain a mixture of hydrocarbons and non-hydrocarbons may be detectable, please consult Det-Tronics for additional information on this subject.

Sunlight

Infrared based flame detectors that operate in the H₂O emission band can become desensitized by modulated sunlight under certain conditions. If the location where the detector is to be installed may expose the detector to modulated sunlight, in order to optimize the detectors performance, Det-Tronics suggests fitting the X3302 with a Q2033A10R 10 degree FOV sight limiter / weather shield accessory. As an option, a sun shield may also be installed. See the Accessories section of this instruction manual for ordering information.

Background Infrared

Infrared (IR) energy is emitted from fire as well as non-fire sources. Because non-fire sources may in some cases emit IR energy in wavelengths that are monitored by the detector, special detector installation and configuration considerations need to be given in these situations.

The detector differentiates fire from non-fire sources by using algorithms that analyze the emission characteristics of the IR energy that is within its field of view (FOV). Typically, non-fire IR sources do not qualify these algorithms. However, if an object or person moves between the non-fire IR source and the detector the randomly modulated IR energy that is produced could mimic a fire signal.

In order to optimize the detector's false alarm rejection performance, it is preferred that the detectors FOV be controlled to the area that requires flame detection monitoring. Whenever possible, sources of intense IR emissions should be eliminated from the detector's FOV. Although elimination of all background IR sources may not be possible, controlling the detectors FOV through careful installation and aiming will help to optimize the detector's performance.

It is recommended that a flame detector that has an intense IR source within its FOV (e.g., turbine enclosure, fin-fan cooler) be inhibited prior to personnel working on or in close proximity to the detector. Consult the factory for software and hardware configurations that can help mitigate the effects of background IR sources.

IMPORTANT SAFETY NOTES



WARNING

Do not open the detector assembly in a hazardous area when power is applied. The detector contains limited serviceable components and should never be opened. Doing so could disturb critical optical alignment and calibration parameters, possibly causing serious damage.



CAUTION

The wiring procedures in this manual are intended to ensure proper functioning of the device under normal conditions. However, because of the many variations in wiring codes and regulations, total compliance to these ordinances cannot be guaranteed. Be certain that all wiring complies with the NEC as well as all local ordinances. If in doubt, consult the authority having jurisdiction before wiring the system. Installation must be done by a properly trained person.



CAUTION

To prevent unwanted actuation or alarm, extinguishing devices must be disabled prior to performing system tests or maintenance.



CAUTION

The multispectrum IR flame detectors are to be installed in places where the risk of mechanical damage is low.

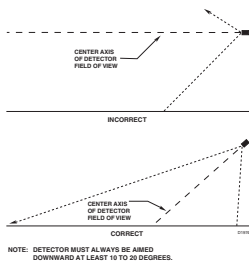

Figure 1—Detector Orientation Relative to Horizon

ATTENTION

Remove the protective cover from the front of the detector before activating the system.

ATTENTION

Observe precautions for handling electrostatic sensitive devices.

INSTALLATION

NOTE

The recommended lubricant for threads and O-rings is a silicone free grease (p/n 005003-001) available from Det-Tronics. Under no circumstances should a lubricant containing silicone be used.

DETECTOR POSITIONING

Detectors should be positioned to provide the best unobstructed view of the area to be protected. The following factors should also be taken into consideration:

- Identify all high risk fire ignition sources.
- Be sure that enough detectors are used to adequately cover the hazardous area.
- Be sure that the unit is easily accessible for cleaning and other periodic servicing.
- Verify that all detectors in the system are properly located and positioned so that any fire hazards are within both the Field of View (FOV) and detection range of the detector. The Q1201C Laser Aimer is recommended for establishing the detector's FOV. Refer to the "High Resolution Field of View Diagrams" for specific information regarding detector range and FOV.
- The detector should be aimed downward at least 10 to 20 degrees to allow lens openings to drain. See Figure 1. **The detector should be positioned so that its FOV does not cover areas outside the area that requires flame detection monitoring.** This will minimize the possibility of false alarms caused by activities outside the area requiring protection.

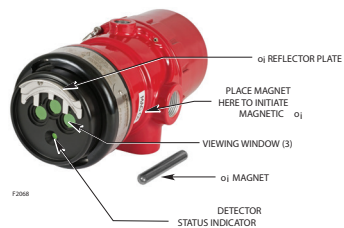

Figure 2—Front View of the X3302

- The detector must be mounted on a rigid surface in a low vibration area.
- Dense fog, rain or ice can absorb IR radiation and reduce the sensitivity of the detector. To ensure optimum performance, be certain that the internal optical heater is enabled on detectors that are used in applications where snow, ice, and/condensation are likely to occur.
- Although IR detectors are less affected by smoke than other detectors, the X3302 should not be placed where rising combustion products can obscure its vision. If smoke is expected before fire, smoke or other alternative detectors should be used in conjunction with the X3302. For indoor applications, if dense smoke is expected to accumulate at the onset of a fire, install the detector on a side wall at least a few feet (approximately 1 meter) down from the ceiling.
- If possible, fire tests can be conducted to verify correct detector positioning and coverage.
- For ATEX/IECEX installations, the X3302 detector housing must be electrically connected to earth ground.

DETECTOR ORIENTATION

Refer to Figure 2 and ensure that the **oj** reflector plate will be oriented as shown when the X3302 is installed and sighted. This will ensure proper operation of the **oj** system and will also minimize the accumulation of moisture and contaminants between the **oj** reflector plate and the viewing windows.

IMPORTANT

*If removed, the **oj** reflector plate must be securely tightened to ensure proper operation of the **oj** system (40 oz./inches [28.2 N.cm] recommended).*

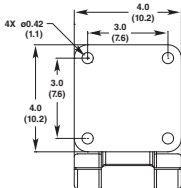

PROTECTION AGAINST MOISTURE DAMAGE

It is important to take proper precautions during installation to ensure that moisture will not come in contact with the electrical connections or components of the system. The integrity of the system regarding moisture protection must be maintained for proper operation and is the responsibility of the installer. Verify all covers are securely tightened upon installation.

If conduit is used, we recommend installing drains, according to local codes, at water collection points to automatically drain accumulated moisture. It is also recommended to install at least one breather, according to local codes, at upper locations to provide ventilation and allow water vapor to escape.

Conduit raceways should be inclined so that water will flow to low points for drainage and will not collect inside enclosures or on conduit seals. If this is not possible, install conduit drains above the seals to prevent the collection of water or install a drain loop below the detector with a conduit drain at the lowest point of the loop.

Conduit seals are not required for compliance with explosion-proof installation requirements, but are highly recommended to prevent water ingress in outdoor applications. Units with M25 threads must use an IP66/IP67 washer to prevent water ingress.

WIRING PROCEDURE

Wire Size and Type

The system should be wired according to local codes. The wire size selected should be based on the number of detectors connected, the supply

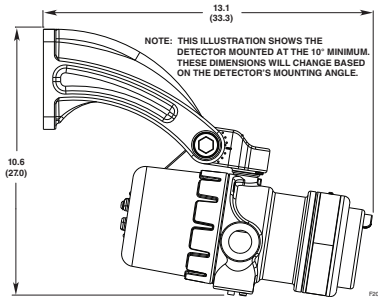

Figure 3—Q9033 Mounting Arm without Collar Attachment Dimensions in Inches (cm)
(See Figure 1 for Correct Detector Orientation.)

voltage and the cable length. Typically 16 AWG, 2.5 mm² shielded cable is recommended. Wires should be stripped 1/2 inch (12 mm). A minimum input voltage of 18 Vdc must be present at the X3302.

NOTE

Refer to "Power Consumption" in the "Specifications" section of this manual.

The use of shielded cable is required to protect against interference caused by EMI and RFI. When using cables with shields, terminate the shields as shown in Figures 8 through 13 and Figure 16. Consult the factory if not using shielded cable.

In applications where the wiring cable is installed in conduit, the conduit must not be used for wiring to other electrical equipment.

If disconnection of power is required, separate disconnect capability must be provided.



WARNING

All entries must contain appropriately rated plugs or fittings. It is required that each plug or fitting be wrench-tightened to an appropriate installation torque and meet the minimum thread engagement requirements per the applicable local standards, codes, and practices in order to retain the defined ratings. PTFE sealant or equivalent should be used on NPT threads.

IMPORTANT

Devices certified for hazardous locations shall be installed in accordance with EN/IEC 60079-14 and NEC 505.



CAUTION

Installation of the detector and wiring should be performed only by qualified personnel.

Detector Installation

Install the mounting arm assembly on a rigid surface. The ideal installation surface should be free of vibration and suitable to receive 3/8 inch or M10 bolts with a length of at least 1 inch (25 mm). The surface must also have sufficient capacity to hold the detector and mounting arm weights (see "Specifications" section). Refer to the Q9033 Mounting Arm and Collar Attachment manual, number 95-8686, for additional installation

information. See Figure 3 for dimensions.

Relay and 0–20 mA Output Models

Follow the instructions below to install the X3302.

1. Make field connections following local ordinances and guidelines in this manual.
 - Figure 4 shows the wiring terminal strip located inside the detector's integral junction box.
 - Figure 5 shows the wiring terminal identification for the X3302 Flame Detector.
 - Figure 6 shows a resistor installed within the integral wiring compartment of the detector (refer to "EOL, Fire, and Fault Resistors" for details).
 - Figures 7, 8, and 9 provide examples of typical installations with a X3302 wired to a fire alarm panel.
 - If the detector is equipped with a 0–20 mA output, refer to Figures 10 through 13.
2. Check all field wiring to be sure that the proper connections have been made.

IMPORTANT

Do not test any wiring connected to the detector with a meg-ohmmeter. Disconnect wiring at the detector before checking system wiring for continuity.

3. Make the final sighting adjustments and use a 14 mm hex wrench to ensure that the mounting arm assembly is tight.

EOL, Fire, and Fault Resistors (Not Used with EQP Model)

To ensure that the insulating material of the wiring terminal block will not be affected by the heat generated by resistors, observe the following guidelines when installing the resistors.

1. Resistors must be rated appropriately for the application and have a maximum power dissipation of 5 watts.

NOTE

This applies to ATEX/IECEx installations only.

2. Resistor leads should be cut to a length of approximately 1 1/2 inches (40 mm).
3. Bend the leads and install the resistors as shown in Figure 6.
4. Maintain a 3/8 inch (10 mm) minimum gap between the resistor body and the terminal block or any other neighboring parts.



Figure 4—X3302 Terminal Block

NOTE

The resistors can only be used within the flameproof (Ex d) terminal compartment. Unused conduit entries shall be closed with suitable blanking elements.

| | | | | | |
|---|------------|----|------------|----|--------------------|
| 9 | mA + | 19 | mA - | 29 | SPARE |
| 8 | mA + REF | 18 | mA - REF | 28 | SPARE |
| 7 | COM FIRE | 17 | COM FIRE | 27 | COM AUX |
| 6 | N.O. FIRE | 16 | N.O. FIRE | 26 | N.O. AUX |
| 5 | N.C. FIRE | 15 | N.C. FIRE | 25 | N.C. AUX |
| 4 | COM FAULT | 14 | COM FAULT | 24 | RS-485 A |
| 3 | N.O. FAULT | 13 | N.O. FAULT | 23 | RS-485 B |
| 2 | +Vin | 12 | +Vin | 22 | MAN O ₁ |
| 1 | -Vin | 11 | -Vin | 21 | -Vin |

Figure 5—X3302 Wiring Terminal Identification

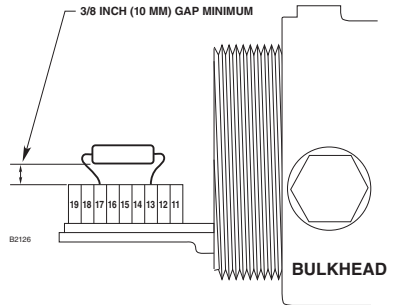

Figure 6—Resistor Installation (For Ex d Wiring only)

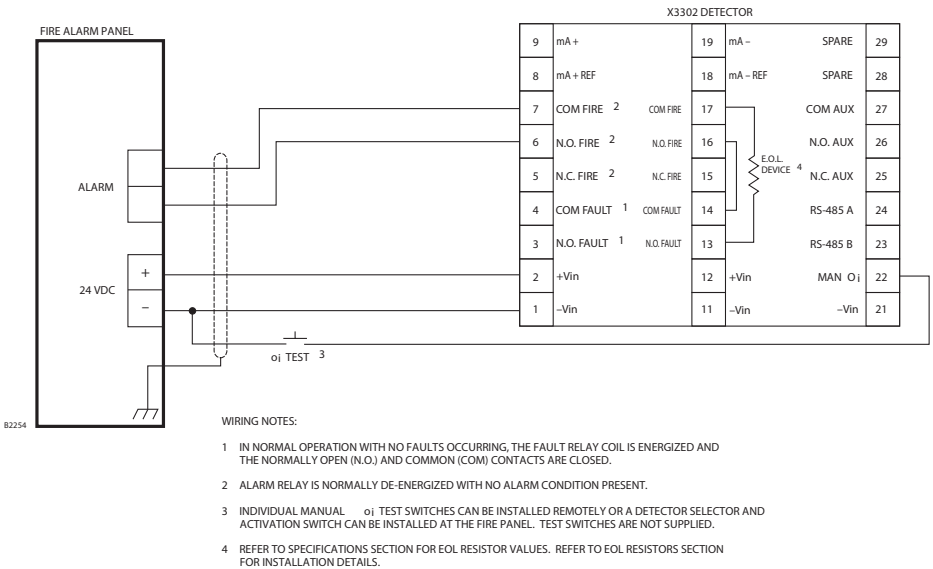
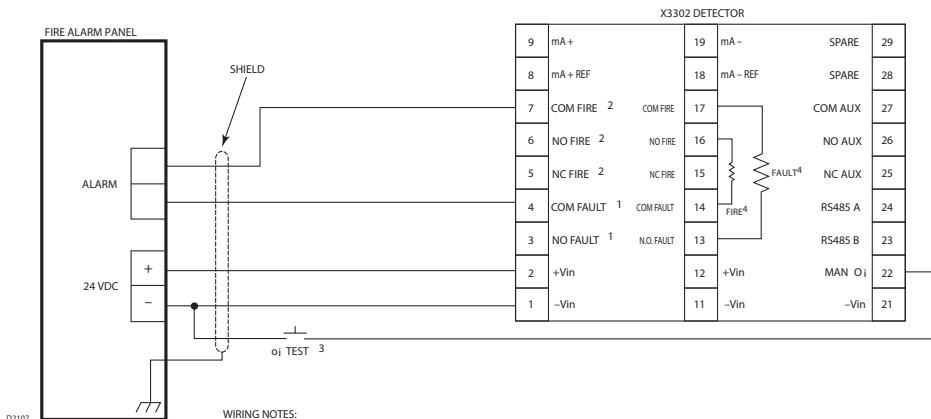
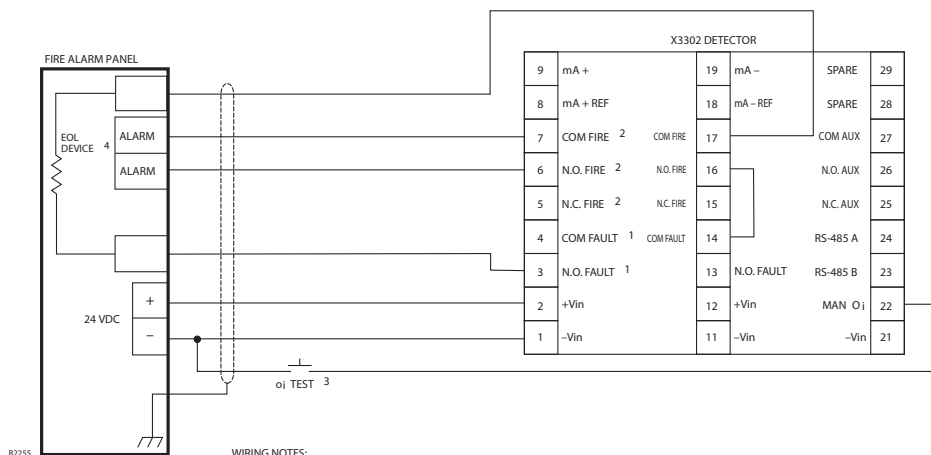

Figure 7—Ex d Wiring Option



- 1 IN NORMAL OPERATION WITH NO FAULTS OCCURRING, THE FAULT RELAY COIL IS ENERGIZED AND THE NORMALLY OPEN (NO) AND COMMON (COM) CONTACTS ARE CLOSED.
- 2 ALARM RELAY IS NORMALLY DE-ENERGIZED WITH NO ALARM CONDITION PRESENT.
- 3 INDIVIDUAL MANUAL oi TEST SWITCHES CAN BE INSTALLED REMOTELY OR A DETECTOR SELECTOR AND ACTIVATION SWITCH CAN BE INSTALLED AT THE FIRE PANEL. TEST SWITCHES ARE NOT SUPPLIED.
- 4 REFER TO EOL, FIRE, AND FAULT RESISTORS SECTION FOR RESISTOR VALUES AND INSTALLATION DETAILS.
- 5 PROPERLY CERTIFIED HAZARDOUS LOCATION METALLIC CABLE GLANDS OR STOP PLUGS ARE REQUIRED TO FILL ALL CONDUIT ENTRIES.
- 6 SHIELD MUST BE CONNECTED TO THE METALLIC CABLE GLAND. MAKE CERTAIN THAT THE INSULATION IS REMOVED TO ENSURE ELECTRICAL CONNECTION BETWEEN THE SHIELD AND THE HOUSING.

Figure 8— Ex d Wiring Option with Fire and Fault resistors



- 1 IN NORMAL OPERATION WITH NO FAULTS OCCURRING, THE FAULT RELAY COIL IS ENERGIZED AND THE NORMALLY OPEN (N.O.) AND COMMON (COM) CONTACTS ARE CLOSED.
- 2 ALARM RELAY IS NORMALLY DE-ENERGIZED WITH NO ALARM CONDITION PRESENT.
- 3 INDIVIDUAL MANUAL oi TEST SWITCHES CAN BE INSTALLED REMOTELY OR A DETECTOR SELECTOR AND ACTIVATION SWITCH CAN BE INSTALLED AT THE FIRE PANEL. TEST SWITCHES ARE NOT SUPPLIED.
- 4 EOL RESISTOR SUPPLIED BY PANEL.

Figure 9—Ex e Wiring Option

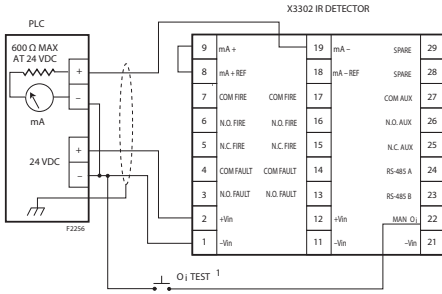

Figure 10—X3302 Detector Wired for Non-Isolated 0 to 20 mA Current Output (Sourcing)

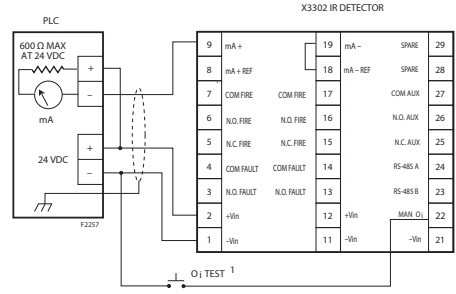

Figure 11—X3302 Detector Wired for Non-Isolated 0 to 20 mA Current Output (Sinking)

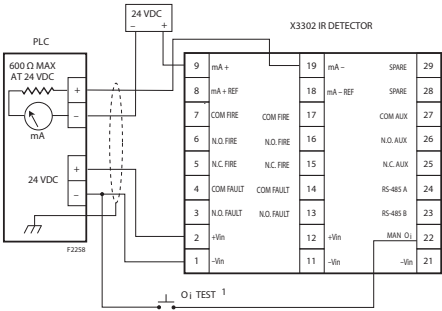

Figure 12—X3302 Detector Wired for Isolated 0 to 20 mA Current Output (Sourcing)

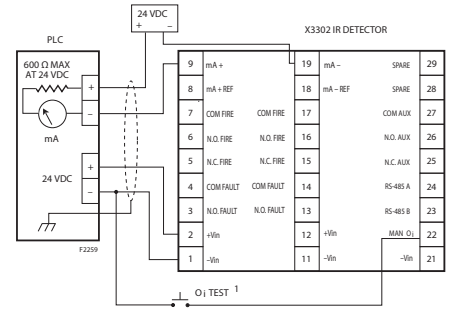

Figure 13—X3302 Detector Wired for Isolated 0 to 20 mA Current Output (Sinking)

NOTES: 1. INDIVIDUAL MANUAL o_1 TEST SWITCHES CAN BE INSTALLED REMOTELY OR A DETECTOR SELECTOR AND ACTIVATION SWITCH CAN BE INSTALLED AT THE FIRE PANEL. TEST SWITCHES ARE NOT SUPPLIED.

EQP Model

1. Connect external wires to the appropriate terminals inside the device junction box, shown in Figure 15. See Figure 16 for terminal identification.
2. Connect the shield of the power cable to “earth ground” at the power source.
3. Connect shields for the LON cable as indicated. See Figure 14.

NOTE

DO NOT ground any shields at the detector housing.

4. With input power disconnected, set the device network address (see the “Setting Device Network Addresses” section of this manual for the switch setting procedure).

5. Check all field wiring to be sure that the proper connections have been made.
6. Replace and securely tighten the device cover before applying input power.
7. Make the final sighting adjustments and use a 14 mm hex wrench to ensure that the mounting arm assembly is tight.

NOTE

Refer to the Eagle Quantum Premier® system manual, number 95-8533, for information regarding power requirements, network communication cable requirements, and configuration.

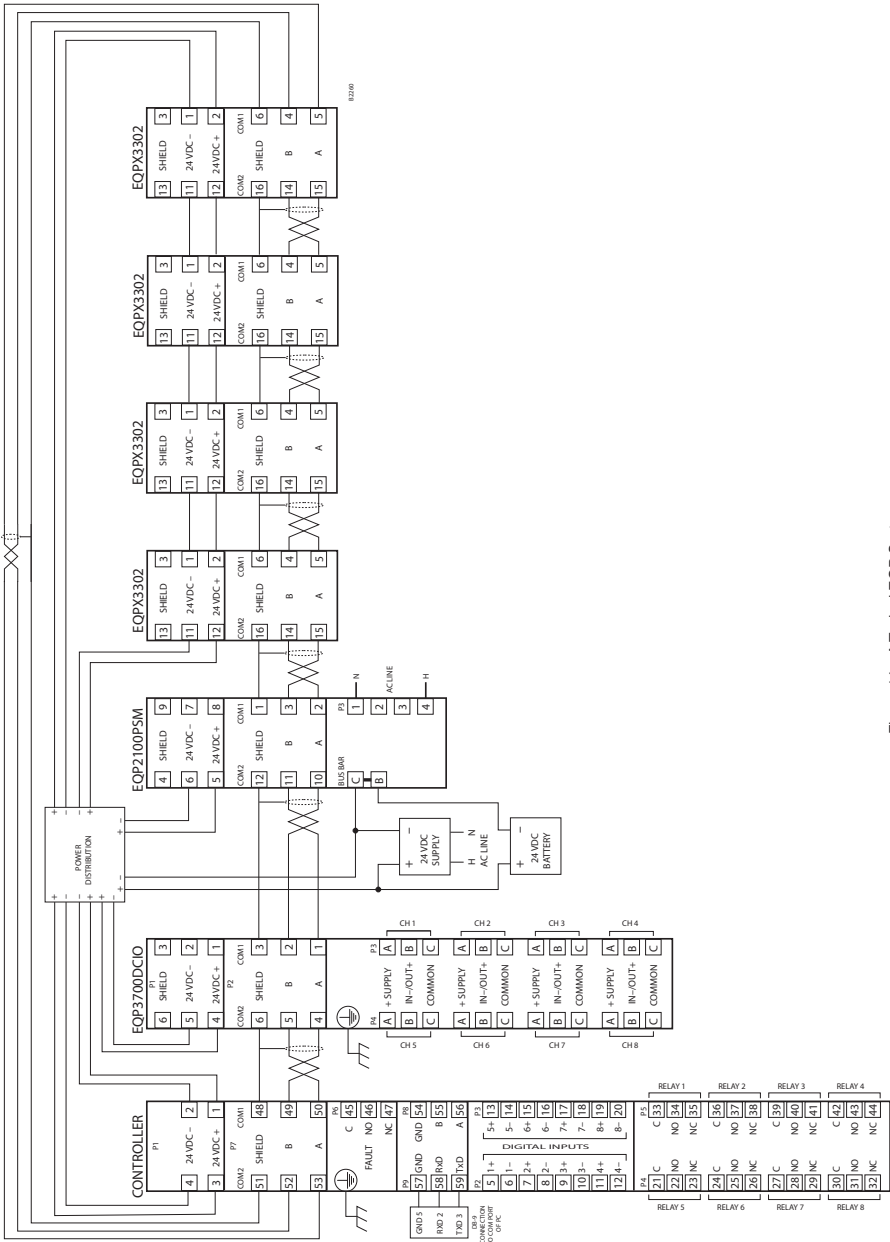

Figure 14—A Typical EQP System



Figure 15—X3302 Terminal Block (EQP Model)

SETTING DEVICE NETWORK ADDRESSES (EQP Model Only)

Overview of Network Addresses

Each device on the LON must be assigned a unique address. Addresses 1 to 4 are reserved for the controller. Valid addresses for field devices are from 5 to 250.

IMPORTANT

If the address is set to zero or an address above 250, the switch setting will be ignored.

Duplicated addresses are not automatically detected. Modules given the same address will use the number given and report to the controller using that address. The status word will show the latest update, which could be from any of the reporting modules using that address.

Setting Field Device Addresses

Selection of the node address is done by setting rocker switches on an 8 switch “DIP Switch Assembly” within the detector’s housing. Refer to Figure 17 for switch location.



WARNING

The network address switches are located within the detector housing. Disassembly of the detector head that contains

powered electrical circuits is required to gain access to the network address switches. For hazardous areas, the area must be de-classified before attempting disassembly of the device. Always observe precautions for handling electrostatic sensitive devices.

The address number is binary encoded with each switch having a specific binary value with switch 1 being the LSB (Least Significant Bit), see Figure 18. The device’s LON address is equal to the added value of all closed rocker switches. All “Open” switches are ignored.

Example: for node No. 5, close rocker switches 1 and 3 (binary values 1 + 4); for node No. 25, close rocker switches 1, 4 and 5 (binary values 1 + 8 + 16).

NOTE

The field device sets the LON address only when power is applied to the device. Therefore, it is important to set the switches before applying power. If an address is ever changed, system power must be cycled before the new address will take effect.

After setting address switches, record the address number and device type.

| | | | |
|---|--------------|----|--------------|
| 6 | COM SHIELD | 16 | COM SHIELD |
| 5 | COM 1 A | 15 | COM 2 A |
| 4 | COM 1 B | 14 | COM 2 B |
| 3 | POWER SHIELD | 13 | POWER SHIELD |
| 2 | +Vin | 12 | +Vin |
| 1 | -Vin | 11 | -Vin |

EQ2089

Figure 16—Wiring Terminal Identification for X3302 EQP Model

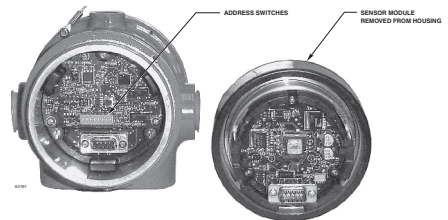
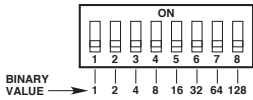

Figure 17—Location of Address Switches



NODE ADDRESS EQUALS THE ADDED VALUE OF ALL CLOSED ROCKER SWITCHES

OPEN = OFF
CLOSED = ON
A2190

Figure 18—Address Switches for X3302

STARTUP PROCEDURE

When installation of the equipment is complete, perform the “Fire Alarm Test” below.

FIRE ALARM TEST

1. Disable any extinguishing equipment that is connected to the system.
2. Apply input power to the system.
3. Initiate an **oi** test (see “Magnetic **oi** / Manual **oi**” under Optical Integrity in the Description section of this manual).
4. Repeat this test for all detectors in the system. If a unit fails the test, refer to the “Troubleshooting” section of this manual.
5. Verify that all detectors in the system are properly aimed at the area to be protected. (The Q1201C Laser Aimer is recommended for this purpose.)
6. Enable extinguishing equipment when the test is complete and the detectors have returned to normal operation.

TROUBLESHOOTING



WARNING

The sensor module (“front” half of the detector) contains no user serviceable components and should never be tampered with.

1. Disable any extinguishing equipment that is connected to the unit.

Table 3—Current Level Output Troubleshooting Guide

| Current Level (±0.3 mA) | Status | Action |
|-------------------------|--------------------------|--|
| 0 mA | Power Fault | Check system wiring |
| 1 mA | General Fault | Cycle power ¹ |
| 2 mA | oi Fault | Clean windows ² |
| 3 mA | High Background IR Fault | Remove IR source or aim detector away from IR source |
| 4 mA | Normal Operation | |
| 20 mA | Fire Alarm | |

¹ If fault continues, return device to factory for repair.

² See “Maintenance” section for cleaning procedure.

NOTE: For additional troubleshooting guides, refer to the Flame Inspector Monitor manual (95-8581).

2. Inspect the viewing windows for contamination and clean as necessary. The detector is relatively insensitive to airborne contaminants, however, thick deposits of ice, dirt, or oil will reduce sensitivity. (Refer to the “Maintenance” section of this manual for complete information regarding cleaning of the detector viewing windows.)
3. Check input power to the unit.
4. If the fire system has a logging function, check the fire panel log for output status information. See Table 3 for information regarding 0–20 mA output.
5. The use of the Enhanced Flame Inspector cable and software from Det-Tronics can be considered to determine the nature of the fault condition. Refer to instruction manual 95-8751 for more information. To order an Enhanced Flame Inspector, see Accessories within the Ordering Information section of this manual.
6. Turn off the input power to the detector and check all wiring for continuity. **Important: Disconnect wiring at the detector before checking system wiring for continuity.**
7. If all wiring checks out and cleaning of the **oi** reflector plate/window did not correct the fault condition, check for high levels of background IR radiation by covering the detector with the factory supplied cover or aluminum foil. If the fault condition clears within six minutes or less, extreme background IR is present. Re-adjust the view of the detector away from the IR source or relocate the detector.
8. Remove the factory supplied cover or aluminum foil from the detector and verify the detector has returned to normal operation before enabling any extinguishing equipment connected to the unit.

If none of these actions corrects the problem, please contact your local Det-Tronics Representative or alternatively you may contact Det-Tronics Technical Support by calling 1-800-165-3473 to obtain assistance.

NOTE

It is highly recommended that a complete spare be kept on hand for field replacement to ensure continuous protection.

MAINTENANCE

IMPORTANT

Periodic flamepath inspections are not recommended, since the product is not intended to be serviced and provides proper ingress protection to eliminate potential deterioration of the flamepaths.

⚠ WARNING

To avoid a potential electrostatic discharge (ESD), the painted surface of the detector should only be cleaned with a damp cloth.

⚠ WARNING

The sensor module ("front" half of the detector) contains no user serviceable components and should never be tampered with.

NOTE

Refer to the X3302 Safety manual, number 95-8720, for specific requirements and recommendations applicable to the proper installation, operation, and maintenance of all SIL-Certified X3302 Flame Detectors.

To maintain maximum sensitivity and false alarm resistance, the viewing windows of the X3302 must be kept relatively clean. Refer to the following procedure for cleaning instructions.

CLEANING PROCEDURE

⚠ CAUTION

Disable any extinguishing equipment that is connected to the unit to prevent unwanted actuation.

To clean the windows and **o_i** reflector plate, use the window cleaner (p/n 001680-001) and a soft cloth, cotton swab, or tissue and refer to the following procedure.

1. **Disable any extinguishing equipment that is connected to the unit.**

2. Since the X3302 is less affected by contamination than other detectors, removal of the **o_i** reflector plate is needed only under extreme conditions. In addition, it is not necessary to achieve perfect cleanliness, because IR is not significantly absorbed by slight films of oil and/or salt. If a fault condition is still indicated after cleaning, remove and clean the **o_i** reflector plate using the **o_i** Reflector Plate Removal and Replacement procedure.
3. Clean all three viewing windows and reflector surfaces thoroughly. Use a cotton swab and the Det-Tronics window cleaning solution. Use Isopropyl alcohol for contaminations that the Det-Tronics window cleaning solution can not remove.

IMPORTANT

When used in extreme environments, the reflective surface of the detector **o_i** reflector plate may eventually deteriorate, resulting in reoccurring **o_i** faults and the need for **o_i** reflector plate replacement.

o_i REFELCTOR PLATE REMOVAL AND REPLACEMENT

1. **Disable any extinguishing equipment that is connected to the unit.**
2. Loosen the two captive screws, then grasp the **o_i** reflector plate by the visor and remove it from the detector. See Figure 19.
3. Install the new (or cleaned) **o_i** reflector plate.

NOTE

When installing the stainless steel **o_i** reflector plate, ensure that the gasket is present and correctly seated to prevent moisture or contaminants from penetrating behind the **o_i** reflector plate. To ensure even seating, tighten both screws equally.

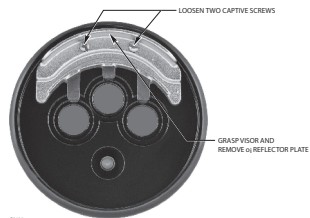

Figure 19—**o_i** Reflector Plate Removal

- Recalibrate the detector's **oi** system. Refer to the Enhanced Flame Inspector manual, number 95-8751, for instructions regarding **oi** reflector plate replacement and **oi** system recalibration.



IMPORTANT

*If the **oi** reflector plate is replaced, you must recalibrate the **oi** system.*

Recalibration of the **oi** system requires the use of the Inspector Connector and Enhanced Flame Inspector Software. These two items are included in the **oi** replacement kit, or they can be purchased separately. See "Ordering Information" for details. The **oi** system may also be recalibrated using HART or Modbus on models that are so equipped.

X3302 oi Reflector Plates

X3302 models are supplied with either a black or a stainless steel **oi** reflector plate. These plates are **not** interchangeable. Order the replacement that matches the **oi** reflector plate on your X3302 Flame Detector.

PERIODIC CHECKOUT PROCEDURE

In compliance with SIL 2, a checkout of the system using the Mag **oi** or Man **oi** feature should be performed regularly to ensure that the system is operating properly. Refer to Table 1 in the X3302 Safety manual, number 95-8720, for frequency of proof tests. To test the system, perform the "Fire Alarm Test" as described in the "Startup Procedure" section of this manual.

CLOCK BATTERY

The real time clock has a backup battery that will operate the clock with no external power. Return the device to the factory for battery replacement if needed.

NOTE

If the backup battery is depleted, there is no effect on the operation of the flame detector, but the time stamping of the data log may be affected.

FEATURES

- Unequaled false alarm rejection
- Responds to a fire in the presence of modulated blackbody radiation (i.e., heaters, ovens, turbines) without false alarm
- Microprocessor controlled heated optics for increased resistance to moisture and ice
- Automatic, manual or magnetic **oi** testing
- Easily replaceable **oi** reflector plate
- Fire, fault and auxiliary relays standard
- 0–20 mA isolated output (optional)
- Eagle Quantum Premier® LON/SLC output (optional)
- Sustained Fire Mode (optional)
- HART communication (optional)
- FDT/DTM capable
- Multiple sensitivity levels
- A tri-color LED on the detector faceplate indicates normal condition and notifies personnel of fire alarm or fault conditions
- Operates under adverse weather conditions and in dirty environments
- Mounting arm allows easy sighting
- Integral wiring compartment for ease of installation
- Explosion-proof/flame-proof detector housing. Meets FM, CSA, ATEX Directive and IECEx certification requirements
- Class A wiring per NFPA-72
- 5 year warranty
- RFI and EMC Directive compliant

Associated Manuals

| TITLE | FORM NUMBER |
|--|--------------------|
| Pulse | 95-8779 |
| EQP | 95-8533 |
| SIL 2 (Safety) | 95-8720 |
| HART Addendum | 95-8613 |
| Q9033 Mounting Arm and Collar Attachment | 95-8686 |
| Enhanced Flame Inspector Software for X-Series Flame Detectors | 95-8751 |
| Q1130 Flange Mount | 95-8662 |

SPECIFICATIONS

OPERATING VOLTAGE—

24 Vdc nominal (18 Vdc minimum, 30 Vdc maximum). Maximum ripple is 2 volts peak-to-peak.

POWER CONSUMPTION—

Without heater: 4 watts at 24 Vdc nominal;
5.2 watts at 24 Vdc in alarm.
4.5 watts at 30 Vdc nominal;
6.5 watts at 30 Vdc in alarm.
Heater only: 8 watts maximum.
Total power: 17 watts at 30 Vdc with EOL resistor installed and heater on maximum.

For HART model, refer to Addendum number 95-8613.

POWER UP TIME—

Fault indication clears after 0.5 second; device is ready to indicate an alarm condition after 30 seconds.

OUTPUT RELAYS—

Fire Alarm relay, Form C, 5 amperes at 30 Vdc:

The Fire Alarm relay has redundant terminals and normally open / normally closed contacts, normally de-energized operation, and latching or non-latching operation.

Fault relay, Form A, 5 amperes at 30 Vdc:

The Fault relay has redundant terminals and normally open contacts, normally energized operation, and latching or non-latching operation.

Auxiliary relay, Form C, 5 amperes at 30 Vdc:

The auxiliary relay has normally open / normally closed contacts, normally energized or de-energized operation, and latching or non-latching operation.

CURRENT OUTPUT (OPTIONAL)—

0-20 milliampere (± 0.3 mA) dc current, with a maximum loop resistance of 500 ohms from 18-19.9 Vdc and 600 ohms from 20-30 Vdc.

LON OUTPUT (OPTIONAL)—

Digital communication, transformer isolated (78.5 kbps).

TEMPERATURE RANGE—

Operating: -40°F to $+167^{\circ}\text{F}$ (-40°C to $+75^{\circ}\text{C}$).
Storage: -67°F to $+185^{\circ}\text{F}$ (-55°C to $+85^{\circ}\text{C}$).
Hazardous location ratings from -55°C to $+125^{\circ}\text{C}$.

HUMIDITY RANGE—

0-95% relative humidity, can withstand 100% condensing humidity for short periods of time.

CONE OF VISION—

The detector has a 90° cone of vision (horizontal) and a 75° cone of vision (vertical).

Refer to Appendix A for FM Approved cone of vision data.

RESPONSE TIME—

Typical response times are under 10 seconds.

DIMENSIONS—

See Figure 20.

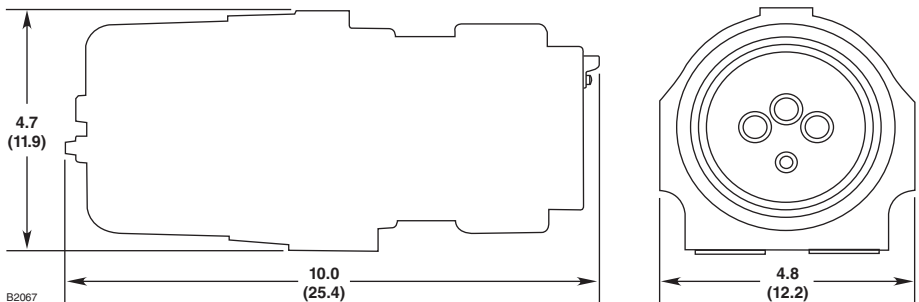

Figure 20—X3302 Dimensions in Inches (cm)

ENCLOSURE MATERIAL—

Copper-free aluminum (painted) or Stainless Steel (316/CF8M Cast).

VIBRATION—

Conformance per FM 3260: 2018, MIL-STD 810C (Curve AW).

WIRING—

Field wiring screw terminals are UL/CSA rated for up to 14 AWG wire, and are DIN/VDE rated for 2.5 mm² wire. Screw terminal required torque range is 3.5 in.-lbs. (0.4 N-m).

Important: 18 Vdc minimum must be available at the detector. For ambient temperatures below -10°C (14°F) and above +60°C (140°F) use field wiring suitable for both minimum and maximum ambient temperature.

THREAD SIZE—

Conduit connection: Four entries, 3/4 inch NPT or M25. Conduit seal not required.

SHIPPING WEIGHT (APPROXIMATE)—

Aluminum: 7 pounds (3.2 kilograms).
Stainless Steel: 13.8 pounds (6.3 kilograms).
Mounting Arm (AL): 6 pounds (2.75 kilograms).
Mounting Arm (SS): 14 pounds (6.4 kilograms).

WARRANTY PERIOD—

5 years.

CERTIFICATION—



For complete approval details, refer to the appropriate Appendix:

- Appendix A - FM
- Appendix B - CSA
- Appendix C - ATEX
- Appendix D - IECEx
- Appendix E - EN54 Approvals
- Appendix F - Additional Approvals
- Appendix G - Declaration of Conformity

REPLACEMENT PARTS

The detector is not designed to be repaired in the field. If a problem should develop, refer to the "Troubleshooting" section. If it is determined that the problem is caused by an electronic defect, the device must be returned to the factory for repair.

REPLACEMENT PARTS

| Part Number | Description |
|-------------|---|
| 009208-003 | o_i Replacement kit for X3302 (5 Black Reflector Plates) with Flame Inspector Connector and Software |
| 010831-002 | o_i Replacement kit for X3302 (5 Stainless Steel Reflector Plates) with Flame Inspector Connector and Software |
| 007307-003 | Replacement o_i Reflector Plate for X3302 with Black plate (requires Flame Inspector or HART to calibrate) |
| 010830-002 | Replacement o_i Reflector Plate for X3302 with Stainless Steel plate (requires Flame Inspector or HART to calibrate) |

NOTE: Refer to instruction manual 95-8530 to determine the correct Replacement **o_i** Reflector Plate.

DEVICE REPAIR AND RETURN

Prior to returning devices, contact the nearest local Detector Electronics office so that a Return Material Authorization (RMA) number can be assigned. **A written statement describing the malfunction must accompany the returned device or component to assist and expedite finding the root cause of the failure.**

Pack the unit properly. Always use sufficient packing material. Where applicable, use an antistatic bag as protection from electrostatic discharge.

NOTE

Det-Tronics reserves the right to apply a service charge for repairing returned product damaged as a result of improper packaging.

Return all equipment transportation prepaid to the factory in Minneapolis.

NOTE

It is highly recommended that a complete spare be kept on hand for field replacement to ensure continuous protection.

ORDERING INFORMATION

When ordering, please specify:

X3302 Multispectrum IR Flame Detector

Refer to the X3302 Model Matrix for details

Q9033 Mounting Arm is required:

- Q9033A for aluminum detectors only
- Q9033B for aluminum and stainless steel detectors

ACCESSORIES

| Part Number | Description |
|-------------|--|
| 103881-001 | Converter RS485 to USB |
| 007819-002 | W6300B1003 USB Inspector Connector (Enhanced Flame Inspector software included) |
| 009207-001 | Enhanced Flame Inspector CD |
| 103922-003 | AMS Trex Device Communicator |
| 102740-002 | Magnet |
| 008082-001 | Magnet and Adapter for Extension Pole |
| 007739-001 | Magnet and Extension Pole |
| 007240-001 | Q1116A1001, Air Shield (AL) |
| 007818-001 | Q1118A1001 Aluminum Air Shield/Flange Mount (AL) |
| 007818-002 | Q1118S1001 Stainless Steel Air Shield/Flange Mount (SS) |
| 009177-001 | Q1120A1001 Paint Shield mounting ring (AL) |
| 010857-001 | Q1130A1001 Flange Mount Assembly |
| 006097-002 | Q1201 Laser, Green |
| 102871-001 | Laser Battery, 3V Lithium (laser) |
| 007255-001 | Q1201C1001 X-Series Laser Holder (AL/Plastic) |
| 007338-001 | Q2000A1001 X-Series Weather Shield (AL) |
| 007338-010 | Q2033A10R X3301/X3302 FOV Limiter 10° (AL) |
| 007338-020 | Q2033A20R X3301/X3302 FOV Limiter 20° (AL) |
| 007338-030 | Q2033A30R X3301/X3302 FOV Limiter 30° (AL) |
| 007912-010 | Spare Restrictor Plate 10° (AL) |
| 007912-020 | Spare Restrictor Plate 20° (AL) |
| 007912-030 | Spare Restrictor Plate 30° (AL) |
| 000003-067 | Stainless Steel Sun Shade |
| 000609-026 | 4-Inch Pipe Mount Bracket and U-Bolt Kit |
| 000609-035 | 2-Inch U-Bolt Kit |
| 007290-001 | Q9033B Stainless Steel Mounting Arm Assembly is for aluminum and stainless steel detectors |
| 007290-002 | Q9033A Aluminum Mounting Arm Assembly is for aluminum detectors only |
| 011385-001 | Q9033 Collar Attachment |
| 101197-001 | Stop Plug, 3/4" NPT, AL |
| 101197-004 | Stop Plug, 3/4" NPT, SS |
| 101197-005 | Stop Plug, M25, AL, IP66 |
| 101197-003 | Stop Plug, M25, SS, IP66 |
| 010816-001 | Stop Plug, 20 Pack, 3/4" NPT, AL |
| 010817-001 | Stop Plug, 20 Pack, 3/4" NPT, SS |
| 010818-001 | Stop Plug, 20 Pack, M25, AL, IP66 |
| 010819-001 | Stop Plug, 20 Pack, M25, SS, IP66 |
| 103363-001 | 14 mm Hex Wrench (Steel) |
| 103406-001 | Screwdriver |
| 107427-040 | O-ring - Rear Cover (Viton) - black or brown |
| 005003-001 | 1 oz grease for detectors (silicone-free) |
| 104346-154 | O-ring - Rear Cover (Fluorosilicone) - blue |
| 012549-001 | 1 oz PTFE Silicone-free lubricant |
| 001680-001 | Window cleaner (6 pack) |

X3302 MODEL MATRIX

| MODEL | DESCRIPTION | |
|--------------|---------------------------------|-----------------------------|
| X3302 | Multispectrum IR Flame Detector | |
| | TYPE | MATERIAL |
| | A | Aluminum |
| | S | Stainless Steel (316) |
| | TYPE | THREAD TYPE |
| | 4M | 4 Port, Metric M25 |
| | 4N | 4 Port, 3/4" NPT |
| | TYPE | OUTPUTS |
| | 11 | Relay |
| | 13 | Relay and 0-20 mA |
| | 14 | Eagle Quantum Premier (EQP) |
| | 15 | Relay and Pulse |
| | 23 | HART, Relay and 0-20 mA |
| | TYPE | APPROVALS* |
| | B | INMETRO (Brazil) |
| | S | SIL |
| | T | SIL/FM/CSA/ATEX/IECEX |
| | W | FM/CSA/ATEX/IECEX |
| | TYPE | CLASSIFICATION |
| | 1 | Division/Zone Ex d e |
| | 2 | Division/Zone Ex d |

*Type Approvals can use one or more letters to designate the approvals of the product.

HIGH RESOLUTION FIELD OF VIEW

The following high resolution field of view diagrams depict the detectors horizontal and vertical response to various fires. Note that the response distance indicated in each diagram differs between fuel type, fire size, and the sensitivity configuration of the flame detector.

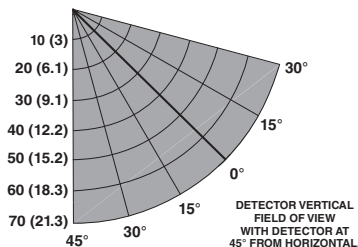
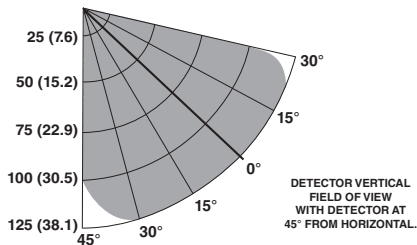
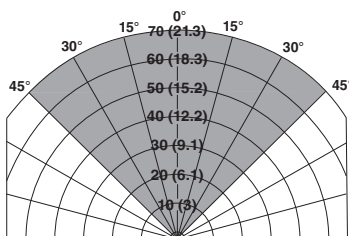
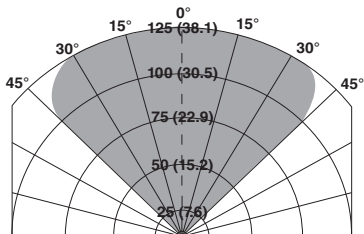

Field of View at Indicated Distance in Feet (m) for **Hydrogen** at **Very High** Sensitivity (30 inch plume, with 100 SLPM flow rate)

Field of View at Indicated Distance in Feet (m) for **Methanol** at **Very High** Sensitivity (1 x 1 ft)

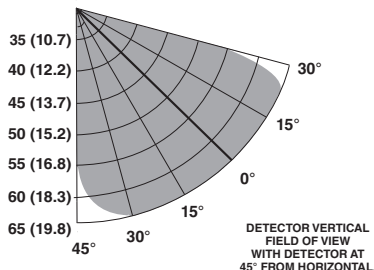
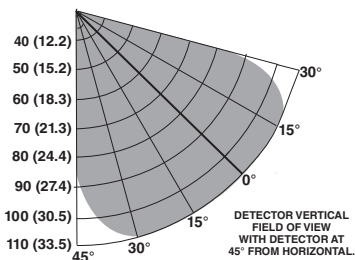
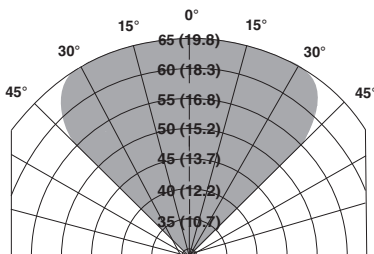
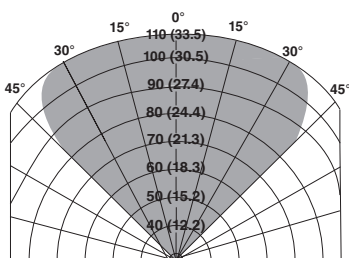

Field of View at Indicated Distance in Feet (m) for **Syngas** at **Very High** Sensitivity (30 inch plume, with 120 SLPM flow rate)

Field of View at Indicated Distance in Feet (m) for **Methane** at **Very High** Sensitivity (30 inch plume, with 40 SLPM flow rate)

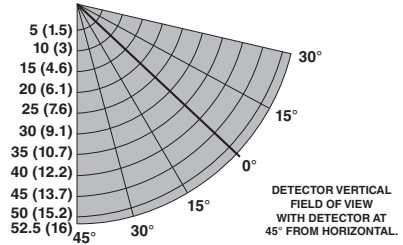
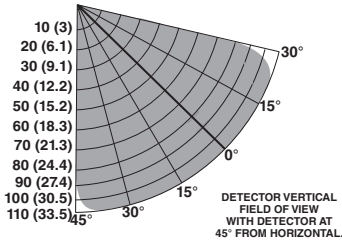
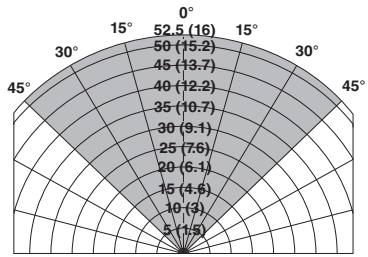
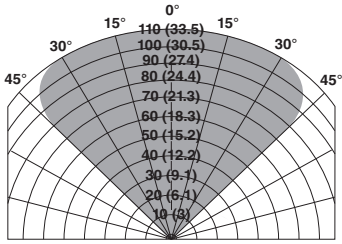

Field of View at Indicated Distance in Feet (m) for **Hydrogen** at **High Sensitivity** (30 inch plume, with 100 SLPM flow rate)

Field of View at Indicated Distance in Feet (m) for **Methanol** at **High Sensitivity** (1 x 1 ft)

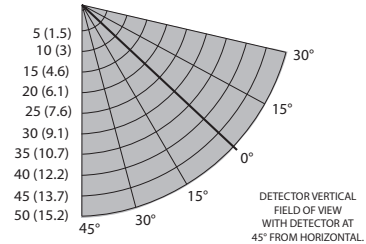
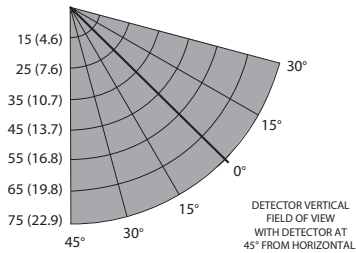
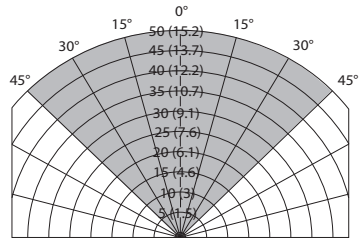
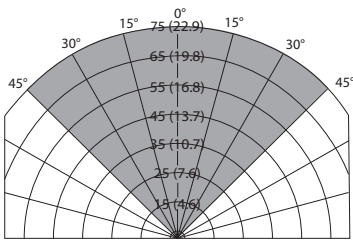

Field of View at Indicated Distance in Feet (m) for **Syngas** at **High Sensitivity** (30 inch plume, with 120 SLPM flow rate)

Field of View at Indicated Distance in Feet (m) for **Methane** at **High Sensitivity** (30 inch plume, with 40 SLPM flow rate)

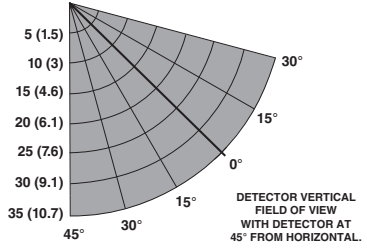
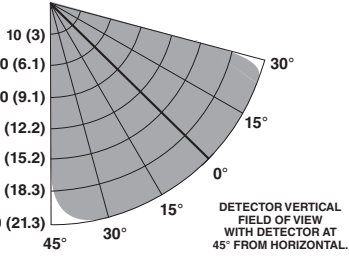
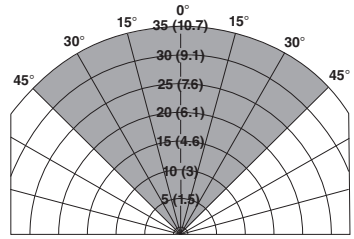
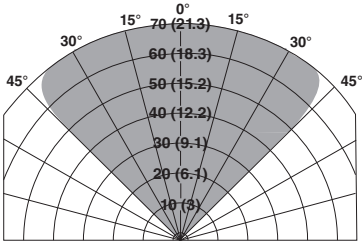

Field of View at Indicated Distance in Feet (m) for **Hydrogen** at **Medium** Sensitivity (30 inch plume, with 100 SLPM flow rate)

Field of View at Indicated Distance in Feet (m) for **Methanol** at **Medium** Sensitivity (1 x 1 ft)

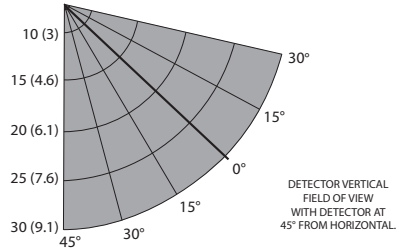
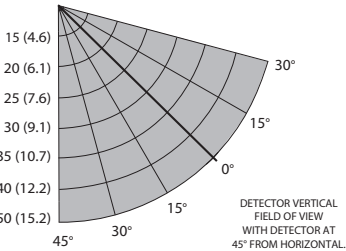
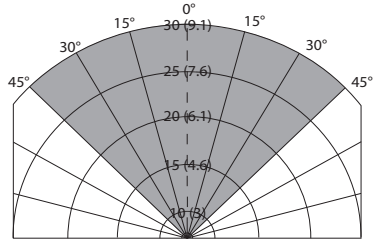
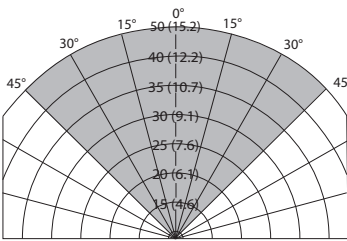

Field of View at Indicated Distance in Feet (m) for **Syngas** at **Medium** Sensitivity (30 inch plume, with 120 SLPM flow rate)

Field of View at Indicated Distance in Feet (m) for **Methane** at **Medium** Sensitivity (30 inch plume, with 40 SLPM flow rate)

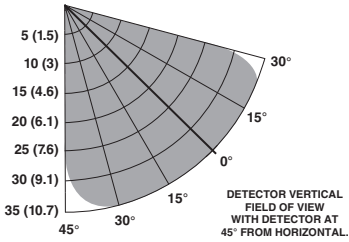
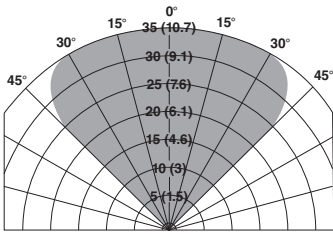

Field of View at Indicated Distance in Feet for **Hydrogen** at **Low Sensitivity** (30 inch plume, with 100 SLPM flow rate)

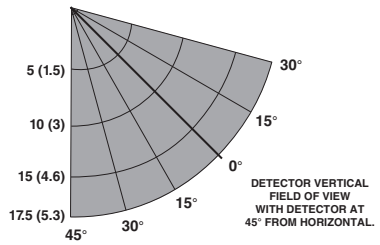
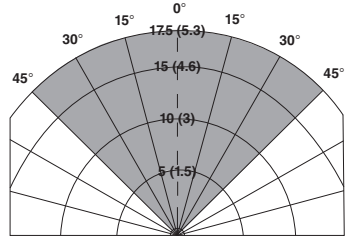

Field of View at Indicated Distance in Feet for **Methanol** at **Low Sensitivity** (1 x 1 ft)

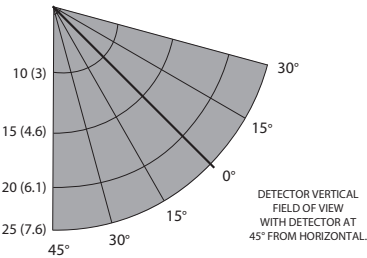
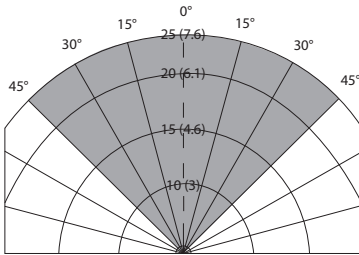

Field of View at Indicated Distance in Feet (m) for **Syngas** at **Low Sensitivity** (30 inch plume, with 120 SLPM flow rate)

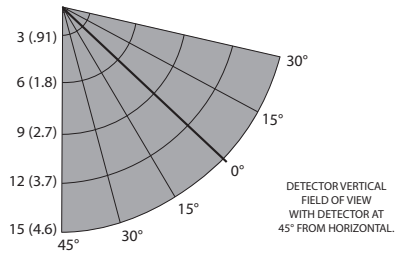
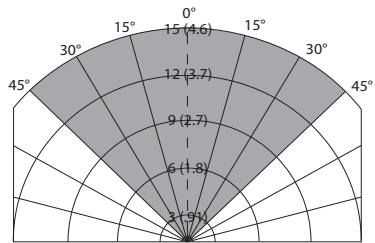

Field of View at Indicated Distance in Feet (m) for **Methane** at **Low Sensitivity** (30 inch plume, with 40 SLPM flow rate)

APPENDIX A

FM APPROVAL AND PERFORMANCE REPORT

THE FOLLOWING ITEMS, FUNCTIONS, AND OPTIONS DESCRIBE THE FM APPROVAL:

- Explosion-proof for Class I, Div. 1, Groups B, C and D (T4A) Hazardous (Classified) Locations per FM 3615.
- Dust-ignition proof for Class II/III, Div. 1, Groups E, F and G (T4A) Hazardous (Classified) Locations per FM 3615.
- Nonincendive for Class I, Div. 2, Groups A, B, C and D (T3C) Hazardous (Classified) Locations per FM 3611.
- Nonincendive for Class II, Div. 2, Groups F and G (T3C) Hazardous (Classified) Locations per FM 3611.
- Enclosure rating NEMA/Type 4X per NEMA 250.
- Ambient Temperature Limits: -40°F to +167°F (-40°C to +75°C).
- Automatic Fire Alarm Signaling Performance verified per FM 3260 (2018).

Flameproof per ANSI/ISA 60079-0, -1, -7, -31

Class I, Zone 1, AEx db eb IIC T6...T5

T6 (Tamb -40°C to +60°C)

T5 (Tamb -40°C to +75°C)

Zone 21, AEx tb IIIC T130°C

Tamb -40°C to +75°C

IP66

Class I, Zone 1, AEx db IIC T6...T5

T6 (Tamb -40°C to +60°C)

T5 (Tamb -40°C to +75°C)

IP66/IP67

The following accessories are FM approved for use with the X3302 Flame Detector:

| Part Number | Description |
|-------------|--|
| 102740-002 | Magnet |
| 007739-001 | Magnet and Extension Pole |
| 010857-001 | Q1130A1001 Flange Mount Assembly |
| 007290-001 | Q9033B Stainless Steel Mounting Arm Assembly is for aluminum and stainless steel detectors |
| 007290-002 | Q9033A Aluminum Mounting Arm Assembly is for aluminum detectors only |
| 011385-001 | Q9033 Collar Attachment |

Special conditions for safe use:

- The front window assembly contains a special cemented joint construction. In accordance with ANSI/ISA 60079-1 clause 5.1.c, all inspections, repair and/or adjustments to this front window assembly shall be done by Detector Electronics Corporation only.
- The EOL resistor can only be used within the flameproof terminal compartment.
- EOL resistors must be ceramic, wirewound type, rated 5 watts minimum, with actual power dissipation not to exceed 2.5 watts.
- The Multispectrum infrared (IR) flame detector type X3302 is to be installed in places where there is a low risk of mechanical damage.
- See the "Maintenance" section of this manual for guidance on minimizing the risk from electrostatic discharge.
- Flameproof joints are not intended to be repaired. See the "Device Repair and Return" section of this manual for more information on conducting repairs.

The following performance criteria were verified:

AUTOMATIC OPTICAL INTEGRITY TEST:

The detector generated an optical fault in the presence of contamination on any single or combination of lens surfaces resulting in a loss of approximately 50% of its detection range, verifying that the detector performs a calibrated Automatic **oi** test for each sensor. Upon removal of the contamination, the detector fault was cleared and the detector was verified to detect a fire.

FM Approval and Performance Report – Continued

MANUAL OPTICAL INTEGRITY TEST:

The Manual / Magnetic **o_i** performs the same calibrated test as the Automatic **o_i**, and additionally actuates the alarm relay to verify output operation. If there is a 50% loss of its detection range, an alarm signal is not generated.

The **o_i** test procedure, as described in the "Magnetic **o_i** / Manual **o_i**" section of this instruction manual, is the approved external optical test method for this detector to verify end-to-end detector function. This test replaces the function and need of a traditional external test lamp.

RESPONSE CHARACTERISTICS

Very High Sensitivity

| Fuel | Size/Flow Rate | Distance feet (m) | Average Response Time (seconds)** |
|-----------|-------------------------|-------------------|-----------------------------------|
| Hydrogen | 30 inch plume/100 SLPM* | 125 (38.1) | 3.4 |
| Methanol | 1 x 1 foot | 70 (21.3) | 3.1 |
| Syngas*** | 30 inch plume/120 SLPM* | 110 (33.5) | 3.5 |
| Methane | 30 inch plume/40 SLPM* | 65 (19.8) | 2.8 |

* Standard Liters Per Minute (Standard conditions defined as +25°C and 14.696 PSIA).

** Add 2 seconds for EQP model.

***Syngas composition: 53% H₂, 24% CH₄, 11% N₂, 8% CO, 4% CO₂.

Very High Sensitivity - Sustained Fire Mode

| Fuel | Size/Flow Rate | Distance feet (m) | Average Response Time (seconds)** |
|----------|-------------------------|-------------------|-----------------------------------|
| Hydrogen | 30 inch plume/100 SLPM* | 125 (38.1) | 9.1 |

* Standard Liters Per Minute (Standard conditions defined as +25°C and 14.696 PSIA).

** Add 2 seconds for EQP model.

High Sensitivity

| Fuel | Size/Flow Rate | Distance feet (m) | Average Response Time (seconds)** |
|-----------|-------------------------|-------------------|-----------------------------------|
| Hydrogen | 30 inch plume/100 SLPM* | 110 (33.5) | 2.0 |
| Methanol | 1 x 1 foot | 52.5 (16.0) | 2.4 |
| Syngas*** | 30 inch plume/120 SLPM* | 75 (22.9) | 1.8 |
| Methane | 30 inch plume/40 SLPM* | 50 (15.2) | 2.6 |

* Standard Liters Per Minute (Standard conditions defined as +25°C and 14.696 PSIA).

** Add 2 seconds for EQP model.

***Syngas composition: 53% H₂, 24% CH₄, 11% N₂, 8% CO, 4% CO₂.

High Sensitivity - Sustained Fire Mode

| Fuel | Size/Flow Rate | Distance feet (m) | Average Response Time (seconds)** |
|----------|-------------------------|-------------------|-----------------------------------|
| Hydrogen | 30 inch plume/100 SLPM* | 110 (33.5) | 8.1 |

* Standard Liters Per Minute (Standard conditions defined as +25°C and 14.696 PSIA).

** Add 2 seconds for EQP model.

Medium Sensitivity

| Fuel | Size/Flow Rate | Distance feet (m) | Average Response Time (seconds)** |
|-------------|-------------------------|--------------------------|--|
| Hydrogen | 30 inch plume/100 SLPM* | 70 (21.3) | 2.4 |
| Methanol | 1 x 1 foot | 35 (10.7) | 3.3 |
| Syngas*** | 30 inch plume/120 SLPM* | 50 (15.2) | 4.5 |
| Methane | 30 inch plume/40 SLPM* | 30 (9.1) | 2.4 |

* Standard Liters Per Minute (Standard conditions defined as +25°C and 14.696 PSIA).

** Add 2 seconds for EQP model.

***Syngas composition: 53% H2, 24% CH4, 11% N2, 8% CO, 4% CO2.

Medium Sensitivity - Sustained Fire Mode

| Fuel | Size/Flow Rate | Distance feet (m) | Average Response Time (seconds)** |
|-------------|-------------------------|--------------------------|--|
| Hydrogen | 30 inch plume/100 SLPM* | 70 (21.3) | 8.1 |

* Standard Liters Per Minute (Standard conditions defined as +25°C and 14.696 PSIA).

** Add 2 seconds for EQP model.

Low Sensitivity

| Fuel | Size/Flow Rate | Distance feet (m) | Average Response Time (seconds)** |
|-------------|---------------------------|--------------------------|--|
| Hydrogen | 30 inch plume / 100 SLPM* | 35 (10.7) | 4.7 |
| Methanol | 1 x 1 foot | 17.5 (5.3) | 5.1 |
| Syngas*** | 30 inch plume/120 SLPM* | 25 (7.6) | 5.1 |
| Methane | 30 inch plume/40 SLPM* | 15 (4.6) | 5.1 |

* Standard Liters Per Minute (Standard conditions defined as +25°C and 14.696 PSIA).

** Add 2 seconds for EQP model.

***Syngas composition: 53% H2, 24% CH4, 11% N2, 8% CO, 4% CO2.

Low Sensitivity - Sustained Fire Mode

| Fuel | Size/Flow Rate | Distance feet (m) | Average Response Time (seconds)** |
|-------------|-------------------------|--------------------------|--|
| Hydrogen | 30 inch plume/100 SLPM* | 35 (10.7) | 9.1 |

* Standard Liters Per Minute (Standard conditions defined as +25°C and 14.696 PSIA).

** Add 2 seconds for EQP model.

FM Approval and Performance Report – Continued

FIELD OF VIEW

Very High Sensitivity

| Fuel | Size/ Flow Rate | Distance feet (m) | Horizontal (degrees) | Horiz. Average Response Time (seconds)** | Vertical (degrees) | Vert. Average Response Time (seconds)** |
|-----------|-----------------------------|----------------------|-------------------------|--|-----------------------|---|
| Hydrogen | 30 inch plume/ 100 SLPM* | 100 (30.5) | +45 | 1.1 | +45 | 2.1 |
| | | | -45 | 2.1 | -30 | 2.4 |
| Methanol | 1 x 1 foot | 70 (21.3) | +45 | 3.8 | +45 | 6.6 |
| | | | -45 | 8.2 | -30 | 4.5 |
| Syngas*** | 30 inch plume/ 120 SLPM* | 85 (25.9) | +45 | 2.6 | +45 | 3.8 |
| | | | -45 | 4.1 | -30 | 1.4 |
| Methane | 30 inch plume/ 40 SLPM* | 55 (16.8) | +45 | 3.3 | +45 | 2.3 |
| | | | -45 | 3.2 | -30 | 3.0 |

* Standard Liters Per Minute (Standard conditions defined as +25°C and 14.696 PSIA).

** Add 2 seconds for EQP model.

***Syngas composition: 53% H₂, 24% CH₄, 11% N₂, 8% CO, 4% CO₂.

Very High Sensitivity – Sustained Fire Mode

| Fuel | Size/ Flow Rate | Distance feet (m) | Horizontal (degrees) | Horiz. Average Response Time (seconds)** | Vertical (degrees) | Vert. Average Response Time (seconds)** |
|----------|-----------------------------|----------------------|-------------------------|--|-----------------------|---|
| Hydrogen | 30 inch plume/ 100 SLPM* | 100 (30.5) | +45 | 8.5 | +45 | 7.7 |
| | | | -45 | 7.1 | -30 | 8.6 |

* Standard Liters Per Minute (Standard conditions defined as +25°C and 14.696 PSIA).

** Add 2 seconds for EQP model.

High Sensitivity

| Fuel | Size/ Flow Rate | Distance feet (m) | Horizontal (degrees) | Horiz. Average Response Time (seconds)** | Vertical (degrees) | Vert. Average Response Time (seconds)** |
|-----------|-----------------------------|----------------------|-------------------------|--|-----------------------|---|
| Hydrogen | 30 inch plume/ 100 SLPM* | 80 (24.4) | +45 | 1.6 | +45 | 2.5 |
| | | | -45 | 2.6 | -30 | 2.9 |
| Methanol | 1 x 1 foot | 52.5 (16.0) | +45 | 3.7 | +45 | 4.0 |
| | | | -45 | 2.9 | -30 | 3.4 |
| Syngas*** | 30 inch plume/ 120 SLPM* | 75 (22.9) | +45 | 2.7 | +45 | 4.2 |
| | | | -45 | 2.8 | -30 | 2.0 |
| Methane | 30 inch plume/ 40 SLPM* | 50 (15.2) | +45 | 2.0 | +45 | 4.1 |
| | | | -45 | 2.3 | -30 | 3.5 |

* Standard Liters Per Minute (Standard conditions defined as +25°C and 14.696 PSIA).

** Add 2 seconds for EQP model.

***Syngas composition: 53% H₂, 24% CH₄, 11% N₂, 8% CO, 4% CO₂.

High Sensitivity – Sustained Fire Mode

| Fuel | Size/ Flow Rate | Distance feet (m) | Horizontal (degrees) | Horiz. Average Response Time (seconds)** | Vertical (degrees) | Vert. Average Response Time (seconds)** |
|----------|-----------------------------|----------------------|-------------------------|--|-----------------------|---|
| Hydrogen | 30 inch plume/ 100 SLPM* | 80 (24.4) | +45 | 7.8 | +45 | 8.1 |
| | | | -45 | 8.7 | -30 | 7.9 |

* Standard Liters Per Minute (Standard conditions defined as +25°C and 14.696 PSIA).

** Add 2 seconds for EQP model.

FM Approval and Performance Report – Continued

Medium Sensitivity

| Fuel | Size/ Flow Rate | Distance feet (m) | Horizontal (degrees) | Horiz. Average Response Time (seconds)** | Vertical (degrees) | Vert. Average Response Time (seconds)** |
|-----------|-----------------------------|----------------------|-------------------------|--|-----------------------|---|
| Hydrogen | 30 inch plume/ 100 SLPM* | 50 (15.2) | +45 | 2.6 | +45 | 2.5 |
| | | | -45 | 2.0 | -30 | 2.2 |
| Methanol | 1 x 1 foot | 35 (10.7) | +45 | 4.3 | +45 | 3.3 |
| | | | -45 | 6.0 | -30 | 4.4 |
| Syngas*** | 30 inch plume/ 120 SLPM* | 50 (15.2) | +45 | 3.6 | +45 | 6.0 |
| | | | -45 | 3.3 | -30 | 3.9 |
| Methane | 30 inch plume/ 40 SLPM* | 30 (9.1) | +45 | 3.1 | +45 | 3.6 |
| | | | -45 | 3.4 | -30 | 2.4 |

* Standard Liters Per Minute (Standard conditions defined as +25°C and 14.696 PSIA).

** Add 2 seconds for EQP model.

***Syngas composition: 53% H₂, 24% CH₄, 11% N₂, 8% CO, 4% CO₂.

Medium Sensitivity – Sustained Fire Mode

| Fuel | Size/ Flow Rate | Distance feet (m) | Horizontal (degrees) | Horiz. Average Response Time (seconds)** | Vertical (degrees) | Vert. Average Response Time (seconds)** |
|----------|-----------------------------|----------------------|-------------------------|--|-----------------------|---|
| Hydrogen | 30 inch plume/ 100 SLPM* | 50 (15.2) | +45 | 8.1 | +45 | 9.9 |
| | | | -45 | 7.8 | -30 | 8.3 |

* Standard Liters Per Minute (Standard conditions defined as +25°C and 14.696 PSIA).

** Add 2 seconds for EQP model.

Low Sensitivity

| Fuel | Size/ Flow Rate | Distance feet (m) | Horizontal (degrees) | Horiz. Average Response Time (seconds)** | Vertical (degrees) | Vert. Average Response Time (seconds)** |
|-----------|-----------------------------|----------------------|-------------------------|---|-----------------------|---|
| Hydrogen | 30 inch plume/ 100 SLPM* | 25 (7.6) | +45 | 5.4 | +45 | 6.4 |
| | | | -45 | 5.3 | -30 | 4.7 |
| Methanol | 1 x 1 foot | 17.5 (5.3) | +45 | 7.6 | +45 | 7.0 |
| | | | -45 | 7.5 | -30 | 4.9 |
| Syngas*** | 30 inch plume/ 120 SLPM* | 25 (7.6) | +45 | 7.1 | +45 | 6.9 |
| | | | -45 | 5.6 | -30 | 6.1 |
| Methane | 30 inch plume/ 40 SLPM* | 15 (4.6) | +45 | 7.2 | +45 | 6.9 |
| | | | -45 | 6.0 | -30 | 4.9 |

* Standard Liters Per Minute (Standard conditions defined as +25°C and 14.696 PSIA).

** Add 2 seconds for EQP model.

***Syngas composition: 53% H₂, 24% CH₄, 11% N₂, 8% CO, 4% CO₂.

Low Sensitivity – Sustained Fire Mode

| Fuel | Size/ Flow Rate | Distance feet (m) | Horizontal (degrees) | Horiz. Average Response Time (seconds)** | Vertical (degrees) | Vert. Average Response Time (seconds)** |
|----------|-----------------------------|----------------------|-------------------------|--|-----------------------|---|
| Hydrogen | 30 inch plume/ 100 SLPM* | 25 (7.6) | +45 | 7.2 | +45 | 7.6 |
| | | | -45 | 8.8 | -30 | 8.4 |

* Standard Liters Per Minute (Standard conditions defined as +25°C and 14.696 PSIA).

** Add 2 seconds for EQP model.

RESPONSE CHARACTERISTICS IN THE PRESENCE OF FALSE ALARM SOURCES

Very High Sensitivity

| False Alarm Source | Distance to source feet (m) | Fire source and size/ flow rate | Distance to fire feet (m) | Average Response time (seconds)** |
|---|-----------------------------|---------------------------------|---------------------------|-----------------------------------|
| Sunlight, direct, unmodulated* | — | Hydrogen @ 100 SLPM | 125 (38.1) | 2.6 |
| Sunlight, direct, modulated* | — | Hydrogen @ 25 SLPM | 10 (3.0) | 7.0 |
| Sunlight, reflected, unmodulated* | — | Hydrogen @ 100 SLPM | 125 (38.1) | 2.6 |
| Sunlight, reflected, modulated* | — | Hydrogen @ 100 SLPM | 60 (18.2) | 2.1 |
| Arc welding, unmodulated | 30 (9.1) | Hydrogen @ 100 SLPM | 125 (38.1) | 3.8 |
| Arc welding, modulated | 40 (12.2) | Hydrogen @ 100 SLPM | 125 (38.1) | 4.6 |
| 70 W sodium vapor lamp, unmodulated | 10 (3.0) | Hydrogen @ 100 SLPM | 125 (38.1) | 2.4 |
| 70 W sodium vapor lamp, modulated | 10 (3.0) | Hydrogen @ 100 SLPM | 125 (38.1) | 2.3 |
| 250 W mercury vapor lamp, unmodulated | 10 (3.0) | Hydrogen @ 100 SLPM | 125 (38.1) | 2.4 |
| 250 W mercury vapor lamp, modulated | 10 (3.0) | Hydrogen @ 100 SLPM | 125 (38.1) | 2.1 |
| 300 W clear incandescent lamp, unmodulated | 10 (3.0) | Hydrogen @ 100 SLPM | 125 (38.1) | 1.4 |
| 300 W clear incandescent lamp, modulated | 10 (3.0) | Hydrogen @ 100 SLPM | 125 (38.1) | 2.3 |
| 500 W shielded quartz halogen lamp, unmodulated | 15 (4.6) | Hydrogen @ 100 SLPM | 125 (38.1) | 1.7 |
| 500 W shielded quartz halogen lamp, modulated | 15 (4.6) | Hydrogen @ 100 SLPM | 125 (38.1) | 4.7 |
| 1500 W electric quartz heater, unmodulated | 15 (4.6) | Hydrogen @ 100 SLPM | 125 (38.1) | 2.7 |
| 1500 W electric quartz heater, modulated | 15 (4.6) | Hydrogen @ 100 SLPM | 125 (38.1) | 3.1 |
| Two 34 W fluorescent lamps, unmodulated | 5 (1.5) | Hydrogen @ 100 SLPM | 125 (38.1) | 2.7 |
| Two 34 W fluorescent lamps, modulated | 5 (1.5) | Hydrogen @ 100 SLPM | 125 (38.1) | 2.2 |
| 4000K, 8000 Lumen LED Lamp, unmodulated | 5 (1.5) | Hydrogen @ 100 SLPM | 125 (38.1) | 1.9 |
| 4000K, 8000 Lumen LED Lamp, modulated | 5 (1.5) | Hydrogen @ 100 SLPM | 125 (38.1) | 2.2 |

* Outdoor test conditions.

** Add 2 seconds for EQP model.

High Sensitivity

| False Alarm Source | Distance to source feet (m) | Fire source and size/ flow rate | Distance to fire feet (m) | Average Response time (seconds)** |
|---|-----------------------------|---------------------------------|---------------------------|-----------------------------------|
| Sunlight, direct, unmodulated* | — | Hydrogen @ 100 SLPM | 110 (33.5) | 1.8 |
| Sunlight, direct, modulated* | — | Hydrogen @ 50 SLPM | 10 (3.0) | 3.2 |
| Sunlight, reflected, unmodulated* | — | Hydrogen @ 100 SLPM | 110 (33.5) | 2.8 |
| Sunlight, reflected, modulated* | — | Hydrogen @ 100 SLPM | 60 (18.3) | 3.2 |
| Arc welding, unmodulated | 25 (7.6) | Hydrogen @ 100 SLPM | 110 (33.5) | 8.5 |
| Arc welding, modulated | 35 (10.7) | Hydrogen @ 100 SLPM | 110 (33.5) | 5.8 |
| 70 W sodium vapor lamp, unmodulated | 8 (2.4) | Hydrogen @ 100 SLPM | 110 (33.5) | 2.2 |
| 70 W sodium vapor lamp, modulated | 8 (2.4) | Hydrogen @ 100 SLPM | 110 (33.5) | 2.1 |
| 250 W mercury vapor lamp, unmodulated | 8 (2.4) | Hydrogen @ 100 SLPM | 110 (33.5) | 2.1 |
| 250 W mercury vapor lamp, modulated | 8 (2.4) | Hydrogen @ 100 SLPM | 110 (33.5) | 2.1 |
| 300 W clear incandescent lamp, unmodulated | 8 (2.4) | Hydrogen @ 100 SLPM | 110 (33.5) | 2.6 |
| 300 W clear incandescent lamp, modulated | 8 (2.4) | Hydrogen @ 100 SLPM | 110 (33.5) | 2.1 |
| 500 W shielded quartz halogen lamp, unmodulated | 12 (3.7) | Hydrogen @ 100 SLPM | 110 (33.5) | 2.4 |
| 500 W shielded quartz halogen lamp, modulated | 12 (3.7) | Hydrogen @ 100 SLPM | 110 (33.5) | 4.7 |
| 1500 W electric quartz heater, unmodulated | 14 (4.3) | Hydrogen @ 100 SLPM | 110 (33.5) | 2.2 |
| 1500 W electric quartz heater, modulated | 14 (4.3) | Hydrogen @ 100 SLPM | 110 (33.5) | 2.5 |
| Two 34 W fluorescent lamps, unmodulated | 4 (1.2) | Hydrogen @ 100 SLPM | 110 (33.5) | 2.7 |
| Two 34 W fluorescent lamps, modulated | 4 (1.2) | Hydrogen @ 100 SLPM | 110 (33.5) | 2.0 |
| 4000K, 8000 Lumen LED Lamp, unmodulated | 4 (1.2) | Hydrogen @ 100 SLPM | 110 (33.5) | 2.0 |
| 4000K, 8000 Lumen LED Lamp, modulated | 4 (1.2) | Hydrogen @ 100 SLPM | 110 (33.5) | 1.4 |

* Outdoor test conditions.

** Add 2 seconds for EQP model.

Medium Sensitivity

| False Alarm Source | Distance to source feet (m) | Fire source and size/ flow rate | Distance to fire feet (m) | Average Response time (seconds)** |
|---|-----------------------------|---------------------------------|---------------------------|-----------------------------------|
| Sunlight, direct, unmodulated* | — | Hydrogen @ 100 SLPM | 70 (21.3) | 2.8 |
| Sunlight, direct, modulated* | — | Hydrogen @ 100 SLPM | 10 (3.0) | 2.6 |
| Sunlight, reflected, unmodulated* | — | Hydrogen @ 100 SLPM | 70 (21.3) | 1.9 |
| Sunlight, reflected, modulated* | — | Hydrogen @ 100 SLPM | 30 (9.1) | 1.6 |
| Arc welding, unmodulated | 20 (6.1) | Hydrogen @ 100 SLPM | 70 (21.3) | 5.0 |
| Arc welding, modulated | 25 (7.6) | Hydrogen @ 100 SLPM | 70 (21.3) | 7.2 |
| 70 W sodium vapor lamp, unmodulated | 5 (1.5) | Hydrogen @ 100 SLPM | 70 (21.3) | 2.2 |
| 70 W sodium vapor lamp, modulated | 5 (1.5) | Hydrogen @ 100 SLPM | 70 (21.3) | 2.6 |
| 250 W mercury vapor lamp, unmodulated | 5 (1.5) | Hydrogen @ 100 SLPM | 70 (21.3) | 2.3 |
| 250 W mercury vapor lamp, modulated | 5 (1.5) | Hydrogen @ 100 SLPM | 70 (21.3) | 3.6 |
| 300 W clear incandescent lamp, unmodulated | 5 (1.5) | Hydrogen @ 100 SLPM | 70 (21.3) | 1.9 |
| 300 W clear incandescent lamp, modulated | 5 (1.5) | Hydrogen @ 100 SLPM | 70 (21.3) | 2.1 |
| 500 W shielded quartz halogen lamp, unmodulated | 10 (3.0) | Hydrogen @ 100 SLPM | 70 (21.3) | 2.0 |
| 500 W shielded quartz halogen lamp, modulated | 10 (3.0) | Hydrogen @ 100 SLPM | 70 (21.3) | 3.3 |
| 1500 W electric quartz heater, unmodulated | 10 (3.0) | Hydrogen @ 100 SLPM | 70 (21.3) | 2.4 |
| 1500 W electric quartz heater, modulated | 10 (3.0) | Hydrogen @ 100 SLPM | 70 (21.3) | 4.9 |
| Two 34 W fluorescent lamps, unmodulated | 3 (0.9) | Hydrogen @ 100 SLPM | 70 (21.3) | 2.3 |
| Two 34 W fluorescent lamps, modulated | 3 (0.9) | Hydrogen @ 100 SLPM | 70 (21.3) | 2.5 |
| 4000K, 8000 Lumen LED Lamp, unmodulated | 3 (0.9) | Hydrogen @ 100 SLPM | 70 (21.3) | 2.5 |
| 4000K, 8000 Lumen LED Lamp, modulated | 3 (0.9) | Hydrogen @ 100 SLPM | 70 (21.3) | 1.7 |

* Outdoor test conditions.

** Add 2 seconds for EQP model.

Low Sensitivity

| False Alarm Source | Distance to source feet (m) | Fire source and size/ flow rate | Distance to fire feet (m) | Average Response time (seconds)** |
|---|-----------------------------|---------------------------------|---------------------------|-----------------------------------|
| Sunlight, direct, unmodulated* | — | Hydrogen @ 100 SLPM | 35 (10.7) | 5.1 |
| Sunlight, direct, modulated* | — | Hydrogen @ 200 SLPM | 10 (3.0) | 7.1 |
| Sunlight, reflected, unmodulated* | — | Hydrogen @ 100 SLPM | 35 (10.7) | 5.2 |
| Sunlight, reflected, modulated* | — | Hydrogen @ 100 SLPM | 15 (4.6) | 4.8 |
| Arc welding, unmodulated | 15 (4.6) | Hydrogen @ 100 SLPM | 35 (10.7) | 6.9 |
| Arc welding, modulated | 15 (4.6) | Hydrogen @ 100 SLPM | 35 (10.7) | 8.9 |
| 70 W sodium vapor lamp, unmodulated | 3 (0.9) | Hydrogen @ 100 SLPM | 35 (10.7) | 5.0 |
| 70 W sodium vapor lamp, modulated | 3 (0.9) | Hydrogen @ 100 SLPM | 35 (10.7) | 4.0 |
| 250 W mercury vapor lamp, unmodulated | 3 (0.9) | Hydrogen @ 100 SLPM | 35 (10.7) | 4.8 |
| 250 W mercury vapor lamp, modulated | 3 (0.9) | Hydrogen @ 100 SLPM | 35 (10.7) | 6.6 |
| 300 W clear incandescent lamp, unmodulated | 3 (0.9) | Hydrogen @ 100 SLPM | 35 (10.7) | 4.9 |
| 300 W clear incandescent lamp, modulated | 3 (0.9) | Hydrogen @ 100 SLPM | 35 (10.7) | 4.7 |
| 500 W shielded quartz halogen lamp, unmodulated | 6 (1.8) | Hydrogen @ 100 SLPM | 35 (10.7) | 5.2 |
| 500 W shielded quartz halogen lamp, modulated | 6 (1.8) | Hydrogen @ 100 SLPM | 35 (10.7) | 5.9 |
| 1500 W electric quartz heater, unmodulated | 8 (2.4) | Hydrogen @ 100 SLPM | 35 (10.7) | 4.8 |
| 1500 W electric quartz heater, modulated | 8 (2.4) | Hydrogen @ 100 SLPM | 35 (10.7) | 9.3 |
| Two 34 W fluorescent lamps, unmodulated | 2 (0.6) | Hydrogen @ 100 SLPM | 35 (10.7) | 4.7 |
| Two 34 W fluorescent lamps, modulated | 2 (0.6) | Hydrogen @ 100 SLPM | 35 (10.7) | 4.3 |
| 4000K, 8000 Lumen LED Lamp, unmodulated | 2 (0.6) | Hydrogen @ 100 SLPM | 35 (10.7) | 4.7 |
| 4000K, 8000 Lumen LED Lamp, modulated | 2 (0.6) | Hydrogen @ 100 SLPM | 35 (10.7) | 4.9 |

* Outdoor test conditions.

** Add 2 seconds for EQP model.

APPENDIX B

CSA APPROVAL

Multispectrum IR Flame Detector/Controller X3302 Series, rated 18-30 Vdc, 4.6 Watts to 17 Watts.
Relay contacts rated 30 Vdc, 5 Amps.

DIVISION CLASSIFICATION:

CLASS 4818 04 - SIGNAL APPLIANCES - Systems - For Hazardous Locations
Class I, Division 1, Groups B, C, and D (T4A); Class II, Division 1, Groups E, F, and G (T4A);
Class I, Division 2, Groups A, B, C, and D (T3C); Class II, Division 2, Groups F and G (T3C);
Class III; Enclosure NEMA/Type 4X;
Conduit seal not required.

APPLICABLE REQUIREMENTS

- CAN/CSA-C22.2 No. 0-M91 – General Requirements — Canadian Electrical Code, Part II
- CAN/CSA-C22.2 No. 25-1966 – Enclosures for use in Class II Groups E, F & G Hazardous Locations
- CAN/CSA-C22.2 No. 30-M1986 – Explosion-Proof Enclosures for use in Class I Hazardous Locations
- CAN/CSA-C22.2 No. 94-M91 – Special Purpose Enclosures
- CAN/CSA-C22.2 No. 142-M1987 – Process Control Equipment
- CAN/CSA-C22.2 No. 213-M1987 – Nonincendive Electrical Equipment for use in Class I, Division 2 Hazardous Locations

ZONE CLASSIFICATION:

CLASS 4818 04 - SIGNAL APPLIANCES - Systems - For Hazardous Locations

- | | |
|--|---|
| <p>Ex db eb IIC T6...T5 T6 (Ta -50°C to +60°C) T5 (Ta -50°C to +75°C) Ex tb IIIC 130°C (Tamb = -50°C to +75°C) Seal required adjacent to enclosure IP66.</p> | <p>Ex db IIC T6...T5 T6 (Ta -55°C to +60°C) T5 (Ta -55°C to +75°C) Seal required adjacent to enclosure IP66/IP67.</p> |
|--|---|

APPLICABLE REQUIREMENTS

- CAN/CSA-C22.2 No. 60079-0:2015 – Electrical apparatus for explosive gas atmospheres. Part 0: General requirements
- CAN/CSA-C22.2 No. 60079-1:2016 – Explosive atmospheres. Part 1: Equipment protection by flameproof enclosures "d"
- CAN/CSA-C22.2 No. 60079-7:2012 – Explosive atmospheres. Part 7: Equipment protection by increased safety "e"
- CAN/CSA-C22.2 No. 60079-31:2015 – Equipment dust ignition protection by enclosure "t"

The following accessories are CSA approved for use with the X3302 Flame Detector:

| Part Number | Description |
|-------------|--|
| 102740-002 | Magnet |
| 007739-001 | Magnet and Extension Pole |
| 010857-001 | Q1130A1001 Flange Mount Assembly |
| 007290-001 | Q9033B Stainless Steel Mounting Arm Assembly is for aluminum and stainless steel detectors |
| 007290-002 | Q9033A Aluminum Mounting Arm Assembly is for aluminum detectors only |
| 011385-001 | Q9033 Collar Attachment |

APPENDIX C

ATEX APPROVAL

EC-TYPE EXAMINATION CERTIFICATE

DEMKO 01 ATEX 130204X

Increased Safety Model

CE 0539 

Ex db eb IIC T6...T5 Gb
Ex tb IIIC T130°C Db
T6 (Tamb = -50°C to +60°C)
T5 (Tamb = -50°C to +75°C)
IP66.

Flameproof Model

CE 0539 

Ex db IIC T6...T4 Gb
T6 (Tamb = -55°C to +60°C)
T5 (Tamb = -55°C to +75°C)
T4 (Tamb = -55°C to +125°C)
IP66/IP67.

Compliance with:

EN 60079-0: 2012+A11:2013
EN 60079-1: 2014
EN 60079-7: 2015+A1:2018
EN 60079-31: 2014
EN 60529: 1991+A1:2000+A2:2013.

INSTALLATION INSTRUCTIONS

The field wiring connections in the terminal compartment are ATEX certified and accepts wiring specifications from 14-24 AWG or 2.5-0.2 mm².

The Multispectrum infrared (IR) flame detector type X3302 shall be installed according to the instructions given by the manufacturer.

The cable entry devices shall be certified in type of explosion protection flameproof enclosure "d" for use with the terminal compartment in type of explosion protection flameproof enclosure "d", or in type of explosion protection increased safety "e" for use with the terminal compartment in type of explosion protection increased safety "e". They shall be IP66/IP67 rated, suitable for the conditions of use and correctly installed.

Unused entries shall be closed with suitable certified blanking elements.

The metal housing for the Multispectrum infrared (IR) flame detector type X3302 must be electrically connected to earth ground.

For ambient temperatures below -10°C and above +60°C use field wiring suitable for both minimum and maximum ambient temperature.

Special conditions for safe use:

The front window assembly contains a special cemented joint construction. In accordance with EN60079-1 clause 5.1.c, all inspections, repair and/or adjustments to this front window assembly shall be done by Detector Electronics Corporation only.

Up to two resistors may be used within the flameproof terminal compartment only.

Each resistor may dissipate a maximum of 5 watts and must be rated appropriately for the application.

The Multispectrum infrared (IR) flame detector type X3302 is to be installed in places where there is a low risk of mechanical damage.

See the "Maintenance" section of this manual for guidance on minimizing the risk from electrostatic discharge.

Flameproof joints are not intended to be repaired. See the "Device Repair and Return" section of this manual for more information on conducting repairs.

The following accessories are ATEX approved for use with the X3302 Flame Detector:

| Part Number | Description |
|-------------|--|
| 007290-001 | Q9033B Stainless Steel Mounting Arm Assembly is for aluminum and stainless steel detectors |
| 007290-002 | Q9033A Aluminum Mounting Arm Assembly is for aluminum detectors only |
| 011385-001 | Q9033 Collar Attachment |

APPENDIX D

IECEX APPROVAL

IECEX CERTIFICATE OF CONFORMITY

DEMKO

IECEX ULD 06.0017X

Ex db eb IIC T6...T5 Gb

Ex tb IIIC T130°C Db

T6 (Tamb = -50°C to +60°C) or

T5 (Tamb = -50°C to +75°C)

IP66.

Ex db IIC T6...T4 Gb

T6 (Tamb = -55°C to +60°C)

T5 (Tamb = -55°C to +75°C)

T4 (Tamb = -55°C to +125°C)

IP66/IP67.

Compliance with:

IEC 60079-0: 2011, ED. 6

IEC 60079-1: 2014, ED. 7

IEC 60079-7: 2017, ED. 5.1

IEC 60079-31: 2013, ED. 2

IEC 60529: 2013, ED. 2.2.

INSTALLATION INSTRUCTIONS

The field wiring connections in the terminal compartment are suitable certified and accepts wiring specifications from 14-24 AWG or 2.5-0.2 mm².

The Multispectrum infrared (IR) flame detector type X3302 shall be installed according to the instructions given by the manufacturer.

The cable entry devices shall be certified in type of explosion protection flameproof enclosure "d" for use with the terminal compartment in type of explosion protection flameproof enclosure "d" or in type of explosion protection increased safety "e" for use with the terminal compartment in type of explosion protection increased safety "e". They shall be IP66/IP67 rated, suitable for the conditions of use and correctly installed.

Unused entries shall be closed with suitable certified blanking elements.

The metal housing for the Multispectrum infrared (IR) flame detector type X3302 must be electrically connected to earth ground.

For ambient temperatures below -10°C and above +60°C use field wiring suitable for both minimum and maximum ambient temperature.

Special conditions for safe use:

The front window assembly contains a special cemented joint construction. In accordance with IEC 60079-1 clause 5.1.c, all inspections, repair and/or adjustments to this front window assembly shall be done by Detector Electronics Corporation only.

Up to two resistors may be used within the flameproof terminal compartment only.

Each resistor may dissipate a maximum of 5 watts and must be rated appropriately for the application.

The Multispectrum infrared (IR) flame detector type X3302 is to be installed in places where there is a low risk of mechanical damage.

See the "Maintenance" section of this manual for guidance on minimizing the risk from electrostatic discharge.

Flameproof joints are not intended to be repaired. See the "Device Repair and Return" section of this manual for more information on conducting repairs.

The following accessories are IECEx approved for use with the X3302 Flame Detector:

| Part Number | Description |
|-------------|--|
| 007290-001 | Q9033B Stainless Steel Mounting Arm Assembly is for aluminum and stainless steel detectors |
| 007290-002 | Q9033A Aluminum Mounting Arm Assembly is for aluminum detectors only |
| 011385-001 | Q9033 Collar Attachment |

APPENDIX E

EN54 APPROVALS

| Certification Bodies | Conventional Output | |
|--|-----------------------------|-------------------|
| | Certificate/Approval Number | Basis of Approval |
| BRE – Construction Products Regulation | 2831-CPR-F4356 | EN 54 -10 + A1 |
| LPCB | 973e/07 | EN 54 -10 + A1 |

INSTRUCTIONS FOR THE APPLICATION OF THE APPROVAL COMPONENT/SYSTEM

The installation shall take into account, that the orientation arrow on the flame detector is directed upwards, as the view angle in this direction is <90°.

The IR-flame detector configured to very high sensitivity level in normal or sustained fire mode corresponds to Class 3.

The detector's IP66/IP67 rating is not LPCB verified.

The detector has an LPCB approved operating temperature range of -40°C to +75°C.

The following accessories are EN54-10 approved for use with the X3302 Flame Detector:

| Part Number | Description |
|-------------|--|
| 102740-002 | Magnet |
| 007739-001 | Magnet and Extension Pole |
| 007290-001 | Q9033B Stainless Steel Mounting Arm Assembly is for aluminum and stainless steel detectors |
| 007290-002 | Q9033A Aluminum Mounting Arm Assembly is for aluminum detectors only |
| 011385-001 | Q9033 Collar Attachment |

APPENDIX F

ADDITIONAL APPROVALS

SIL 2



IEC 61508

Certified SIL 2 Capable.

Applies to specific models – refer to the SIL 2 Certified X3302 Safety manual (95-8720) for details.

BRAZIL



UL-BR 12.0093X

Ex db eb IIC T6...T5

Ex tb IIIC T130°C

T6 (Tamb = -50°C to +60°C)

T5 (Tamb = -50°C to +75°C)

IP66

– or –

Ex db IIC T6...T4

T6 (Tamb = -55°C to +60°C)

T5 (Tamb = -55°C to +75°C)

T4 (Tamb = -55°C to +125°C)

IP66/IP67

APPENDIX G

DECLARATION OF CONFORMITY



EU Declaration of Conformity

Model X3302 (Multispectrum Infrared Flame Detector) 014052-XXX, 022XXX-XXX, 028XXX-XXX, 029XXX-XXX

The object of the declaration described above is in conformity with the relevant Union harmonisation legislation:

| | |
|--|--|
| ATEX Directive: 2014/34/EU Certificate No.: DEMKO 01 ATEX 130204X Issued by: DEMKO | EN 60079-0:2012+A11:2013 EN 60079-1:2014 EN 60079-7:2015+A1:2018 EN 60079-31:2014 |
| EMC Directive: 2014/30/EU | EN 50130-4:2011 EN 61000-6-2:2005 EN 61000-6-4:2007 |
| RoHS Directive: 2011/65/EU | EN 50581:2012 |

QAN by:

UL International DEMKO A/S, NB. No. 0539
Borupvang 5A, 2750 Ballerup, Denmark

 II 2 G Ex db eb IIC T6...T5 Gb IP66/IP67

 II 2 G Ex db IIC T6...T4 Gb IP66/IP67

 II 2 D Ex tb IIIC T130°C Db IP66/IP67

This declaration of conformity is issued under the sole responsibility of the manufacturer

Signature:

2020-10-07

Mike Farrell
Approvals Manager



95-8768



FlexSonic® Acoustic
Leak Detector



X3301 Multispectrum
IR Flame Detector



PointWatch Eclipse® IR
Combustible Gas Detector



FlexVu® Universal Display
with GT3000 Toxic Gas Detector



Eagle Quantum Premier®
Safety System

Specifications subject to change without notice.

All trademarks are the property of their respective owners.

© 2021 Carrier. All Rights Reserved.



Corporate Office
6901 West 110th Street
Minneapolis, MN 55438 USA
www.det-tronics.com

Phone: +1 952.941.6665
Toll-free: +1 800.765.3473
Fax: 952.829.8750
det-tronics@carrier.com