

Instructions

95-8562

Dual Spectrum®
Infrared Flame Detector
PM-5MPX



Table of Contents

APPLICATION	1	APPENDIX A – FM APPROVAL AND PERFORMANCE REPORT	8
DETECTOR USE IN HAZARDOUS AREAS	2	APPENDIX B – CONTROL DRAWING CONFIGURATION	10
ELECTRICAL CHARACTERISTICS	2	APPENDIX C – INTRINSICALLY SAFE CLASS B, STYLE B WIRING	11
ENVIRONMENTAL CHARACTERISTICS	3	APPENDIX D – NON-INCENDIVE CLASS B, STYLE B WIRING	12
DETECTOR PERFORMANCE	3	APPENDIX E – NON-INCENDIVE CLASS A, STYLE D WIRING	13
Detection Range and Response Time	3	APPENDIX F – PSS-MP TEST LAMP	14
False Alarm Immunity	4		
DETECTOR INSTALLATION	4		
Physical Mounting	4		
Electrical Wiring Connection	4		
Intrinsically Safe Circuits	5		
Non-Incendive Circuits	5		
System Test	5		
Optional Test Method	6		
TROUBLESHOOTING	6		
MAINTENANCE	6		
Routine Visual Inspection	6		
Periodic System Test	6		
DEVICE REPAIR AND RETURN	7		
ORDERING INFORMATION	7		

Dual Spectrum® Infrared Flame Detector PM-5MPX

IMPORTANT

Be sure to read and understand the entire instruction manual before installing or operating the Model PM-5MPX Detector. Only qualified personnel should install, maintain or operate the flame detection system.

CAUTION

If this equipment is used in a manner not specified in this manual, safety protection may be impaired.

CAUTION

The wiring procedures in this manual are intended to ensure proper functioning of the device under normal conditions. However, because of the many variations in wiring codes and regulations, total compliance to these ordinances cannot be guaranteed. Be certain that all wiring complies with the NEC as well as all local ordinances. If in doubt, consult the authority having jurisdiction before wiring the system.

The Dual Spectrum® PM-5MPX is a FM Approved infrared flame detector that provides reliable flame detection in semiconductor fabrication facilities and other manufacturing environments. It provides fast protection against fires, has a maximum 110° field-of-view, and is approved for use in hazardous (classified) locations as described below. The detector response to explosive fires is as fast as 25 milliseconds.

The PM-5MPX (P/N 421132) is encapsulated and enclosed in an extremely compact molded polypropylene housing approximately 3.1 x 3.1 x 1.7 inches in size. (See Figure 1.) They are intended for mounting in locations where space is at a premium. The IP67 polypropylene housing is resistant to attack by a broad range of chemicals. The housing has four holes in the mounting flange that allow it to be attached to a bracket or other flat surface. Electrical connections are made via an integral multiconductor cable.



FM Approved for:

- 1) performance of the flame detector per FM 3260: 2000,
- 2) compliance with National Fire Protection Association (NFPA) Standard 72 of the detectors and the installation described in this document,
- 3) the suitability for use in protected semiconductor fabrication areas, as described in the FM Loss Prevention Data Sheets 7-7/17-12, and
- 4) the suitability of the installation for use in hazardous (classified) locations.

NOTE

These detectors are specifically tuned and tested to respond to fires as described in this manual. The detector response to other fuel sources not described in this manual may vary. Please contact Detector Electronics Corporation for further information.

APPLICATIONS

The PM-5MPX is intended for fast detection of hydrocarbon fueled fires in harsh chemical environments. The detector is ideal for semiconductor wet benches and is suitable for clean-rooms, gas cabinets, and other indoor applications.

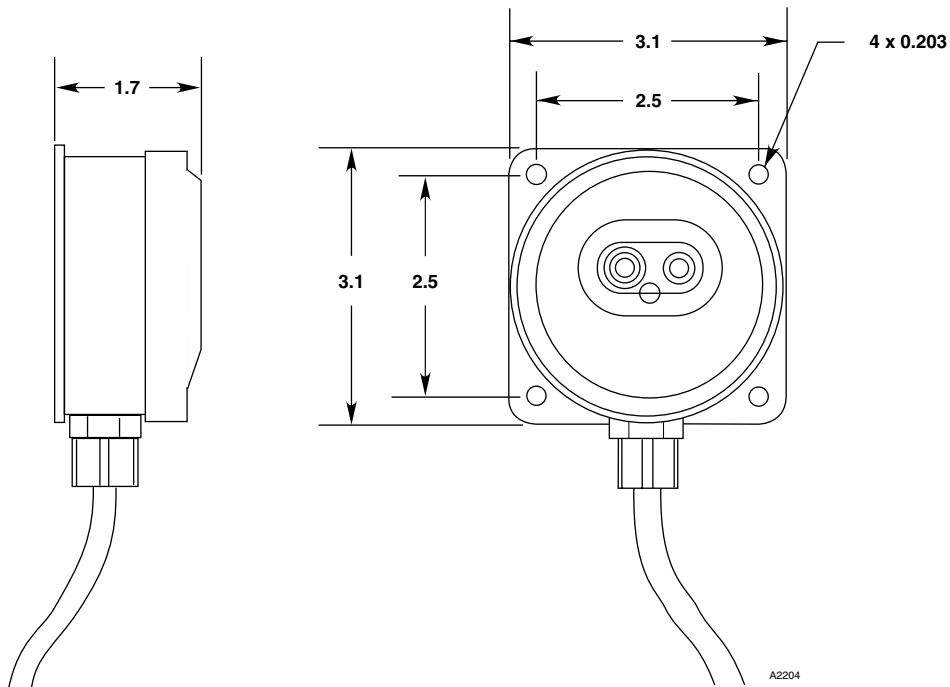

Figure 1—Dimensions of PM-5MPX in Inches

DETECTOR USE IN HAZARDOUS AREAS

The PM-5MPX is FM Approved to FM 3260: 2000, intrinsically safe for use in Class I, II, III, Division 1, Groups C, D, E, F & G hazardous (classified) locations; non-incendive for use in Class I, Division 2 Groups A, B, C & D locations and suitable for use in Class II/III Division 2, Groups F & G. This Approval depends on proper installation and choice of components, which are described in this installation manual. See the following sections and Control Drawing Configuration (Appendix B) for installation instructions and component selection criteria.

ELECTRICAL CHARACTERISTICS

The PM-5MPX is designed to interface to any NFPA type fire alarm control panel. A normally open solid-state relay is provided for an alarm signal. The relay closes for a minimum of five and a maximum of 15 seconds when a fire is detected and is automatically reset after a fire. An internal supervision solid-state relay closes when the detector powers up and opens if a detector fault (such as loss of power or low power supply voltage) occurs. In NFPA 72, Class A or B circuits (see Appendix C, D and E), such a fault condition is indicated at the control panel as a trouble signal. A blinking red LED on the front of the housing indicates the following:

1 Hz rate = Normal operation
3-4 Hz rate = Alarm condition.

OPERATING VOLTAGE—

9 to 30 Vdc at the detector (observe polarity), including line drops and ripple.

NOTE

Detector output is not guaranteed below 9 Vdc. The status LED and relay will reflect this condition.

POWER CONSUMPTION—

10 milliamps maximum at +30 Vdc.

ALARM OUTPUT—

Solid-state alarm relay is non-latching. Contacts close for 5 to 15 seconds.

TROUBLE OUTPUT—

Opening of normally closed solid-state relay.

SOLID-STATE RELAY RATINGS—

100 mA at 30 Vdc; 30 ohms.

STABILIZATION TIME—

Maximum 0.5 second after power up.

RESPONSE TIME—

1 second maximum.

WIRING HARNESS—

Identification: See Table 1.
 Length: 50 feet (15.24 m).
 Diameter: 0.3 inches (7.62 mm).
 Individual Wires: 20 AWG, stranded.

Table 1—PM-5MPX Wiring Harness Identification

Wire Color	Description
Black	Power Return
Brown	Power Return
Red	V+, Input Power
Orange	V+, Input Power
Yellow	Alarm +
Green	Alarm +
Blue	Alarm -
Violet	Alarm -
Gray	Trouble +
White	Trouble -

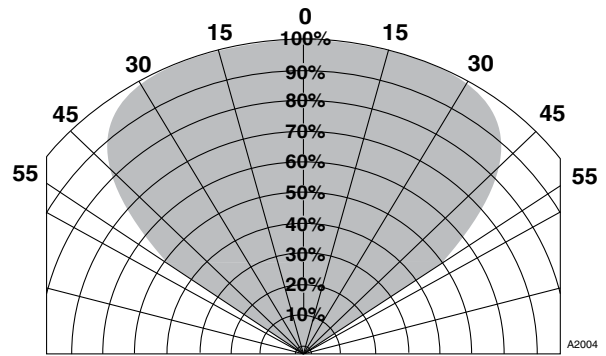

Figure 2—Graphical Representation of Detector Range as a Function of Angle from the Optical Axis

ENVIRONMENTAL CHARACTERISTICS

TEMPERATURE RANGE—

Operating: 0°C to +49°C (+32°F to +120°F).

Storage: 0°C to +70°C (+32°F to +158°F).

RELATIVE HUMIDITY—

0 to 93% relative humidity.

NOTE

Water or other liquids on the face of the detector may decrease sensitivity.

ENCLOSURE RATING—

IP67.

VIBRATION—

Compliance with FM Approval Standard FM 3260: 2000.

ELECTROMAGNETIC INTERFERENCE—

Highly resistant to radiated and conducted Electromagnetic Interference (EMI). The detectors are immune to radiated fields of 100 volts per meter, including amplitude and frequency modulated (AM & FM) signals in the frequency range of 1 MHz to 1 GHz. The detectors can operate in the presence of conducted noise levels up to 1.0 VRMS in the frequency range of 30 Hz to 250 kHz while the input voltage, including noise, remains between 9 and 30 volts.

CERTIFICATION—

FM: Refer to Appendix A for details.

CE: See Special Conditions for Safe Use.

Special Conditions for Safe Use:

- The PM-5MPX Detector may only be installed, connected or removed when the area is known to be non-hazardous.
- The PM-5MPX Detector may only be used in indoor applications that are independent of building fire protection systems.
- The PM-5MPX plastic cover is liable to be damaged by impact. The unit should be installed in such a manner as to protect the cover from mechanical damage.

Conforms with: Low Voltage Directive (2006/95/EC).
Electromagnetic Compatibility Directive (2004/108/EC).

DETECTOR PERFORMANCE

DETECTION RANGE AND RESPONSE TIME

Best performance is achieved when the detector is mounted so that the protected area is within the range, or detection threshold distance (refer to Appendix A for test result data), and within the 110° field of view (see Figure 2). The PM-5MPX detector can respond to fires in as little as 25 milliseconds. Actual detection time depends on the distance between the detector and the fire, the source of fuel, ignition sources and other aspects of the initial fire stages. The detector has a typical response time of <0.5 second to the fires specified in Appendix A. The detector can respond most quickly to closer or larger fires, but is unlikely to detect fires occurring further than the indicated distance. The range is reduced when the fire occurs close to the edge of the field of view of the detector. At the edge ($\pm 55^\circ$ off axis) the range is reduced no more than 50%.

NOTE

The detector range to fires not listed in Appendix A will vary and should be verified by fire tests using the fuel in question. Please contact Detector Electronics Corporation for further information.

FALSE ALARM IMMUNITY

The PM-5MPX is highly resistant to false alarms. However, a fire alarm output due to non-fire stimuli is possible. (Refer to Appendix A for a list of common stimuli and the false alarm immunity distance for those stimuli, as tested by FM Approvals. No false alarms occur for larger distances in laboratory measurements.)

The detector is intended for use in indoor locations. For best performance, the detector should be mounted so that any exposure to false alarm sources occurs only at distances greater than the indicated distances. In addition, to ensure optimum performance, detectors should be mounted so that they do not view very brightly illuminated areas. For example, indoor mounting locations where the detectors look out doors or windows should be avoided.

DETECTOR INSTALLATION

PHYSICAL MOUNTING

The PM-5MPX must be installed in conformance with the appropriate drawing provided in this manual, NFPA-72, the NEC, and all local codes for the hazard classification of the location to be protected. The detector comes with an integral multi-conductor cable for the alarm and power circuits.

CAUTION

The factory sealed front cover is essential to the approval of the detectors. Removing this cover will compromise the performance of the detector.

The compact package of the PM-5MPX is of great benefit in applications where space is a limiting factor. It has four holes in the mounting flange that can be used to mount the detector directly to a flat surface or bracket. Take care not to over-tighten mounting hardware.

The number of detectors required to protect a given area will depend on the size of the area, the distance from the detector and the size and type of the fire threat. Certain factors need to be considered when designing an installation:

1. The detectors should be installed so that objects do not block their field of view. This includes glass, plexiglass, and other visibly transparent materials.
2. Whenever possible, detectors should be installed so their ranges and fields of view overlap.
3. Detectors should be installed so they will not be blocked by moving machinery or personnel during normal operations within the area.
4. To ensure optimum sensitivity and performance, detectors should be installed so they do not view brightly illuminated areas.
5. The detectors should be installed so that they are easily and safely accessible for inspection and maintenance.
6. If mechanical or high-temperature damage, or window contamination is likely in the installed location, then the detectors should be protected. However, the protection method cannot obstruct the detector's field of view with any material, including visibly transparent materials like glass and plexiglass.
7. The detector should be installed in a position higher than the hazard.
8. Installation of detectors in a location prone to submersion must be avoided. Submerged detectors will not detect fire.
9. Detectors should be installed in locations that do not exceed the operating temperature range (including ambient temperature and exposure to liquids).

ELECTRICAL WIRING CONNECTION

An approved installation of the PM-5MPX flame detector must be in accordance with the FM Approved drawings included as appendices to this manual and all local codes. The required drawing for specific hazardous (classified) or non-hazardous locations can be determined from the Control Drawing Configuration (Drawing 420031, Appendix B). Detectors may be wired in a standard NFPA class B, style B configuration or in a class A, style D configuration. Approved initiating device circuits may be either intrinsically safe, non-incendive, or suitable for the classified location as required.

INTRINSICALLY SAFE CIRCUITS

Intrinsically safe installations require the use of suitable and approved barriers, an approved fire alarm control panel that is compatible with the barriers, and wiring methods consistent with ANSI/ISA-RP12.6 and other code. Appendix C calls out the type and quantity of barriers required for installation in hazardous (classified) locations and shows the electrical interconnection to an NFPA compliant fire alarm control panel. Wiring that passes from the non-hazardous location to the hazardous location should pass through a seal appropriate for the type of hazard. All control room instrumentation must operate at less than 250 VRMS.

The barriers may be located in the main control panel or in a separate enclosure, but adequate separation between intrinsically safe and non-intrinsically safe wiring must be observed as defined by ANSI/ISA-RP12.6. Barrier grounds should be connected separately to the same grounding location.

All initiating device wiring should be run in its own separate raceway. Table 2 gives the maximum one way wiring distances based on wire and barrier resistance. It is also important not to exceed the maximum inductance and capacitance listed on the intrinsic safety barriers. This may restrict the maximum cable length to less than the values listed in Table 2. Consult Appendix C for further instructions.

Table 2—Maximum Wiring Distances

AWG (Solid)	Maximum One Way Wiring Distance in Feet (Excluding Integral Cable)
14-18	1000
20	600
22	400

NON-INCENDIVE CIRCUITS

In Class I, Division 2, Group A, B, C, & D locations, the detector may be installed in non-incendive circuits. It is also suitable for installation in Class II/III, Division 2, Group F & G hazardous locations. Installations require the use of an approved fire alarm control panel that is compatible with the Class B, Style B and/or Class A, Style D initiating device circuits. See Appendix D and E.

NOTE

ANSI/NFPA 70 (NEC) Article 501-4(b) requires the use of enclosed gasketed wireways.

SYSTEM TEST

After the fire protection system is installed, it should be tested for correct operation. The detectors may be tested with live fires or by using the hand-held model PSS-MP Test Set P/N 420116. The details of this sequence will vary with particular installations, but the procedure must include the following steps. See Appendix F.

PSS-MP Test Procedure

WARNING

A full system test results in an alarm output. This will result in the automatic suppression system being activated if it is not disabled prior to testing.

1. **Suppression System.** Disable the suppression system if its activation is not desired during this test.

WARNING

Do not use the PSS-MP Test Lamp unless the area is known to be non-hazardous.

2. **Fire Response Test.** Turn on the PSS-MP and wait at least 15 seconds. Direct the beam into the front of the detector to cause an alarm output. Hold the PSS-MP so that the infrared filter is less than 1 inch from the front of the flame detector to be tested as shown in Figure 3. The control panel should indicate an alarm condition at the detector under test. See Appendix F for additional information.



Figure 3—Testing a PM-5MPX with the PSS-MP Test Lamp

3. **Interconnection Wiring.** Correct interconnection wiring should be checked by disconnecting any wire from the multi-conductor cable where it is connected to the power or alarm circuit. The result, in an approved wiring scheme, should be a trouble signal indication at the control panel.
4. **Restore Fire Protection System.** Restore the system to an operational condition after all tests have been completed.

OPTIONAL TEST METHOD

With the detector powered up, the following tests can be done. False alarm immunity can be checked using stimuli and distances shown in the table in Appendix A. Fire response can be checked by exposing the detector under test to a live fire source. (See Appendix A.) Follow all required precautions when testing in this manner.

TROUBLESHOOTING

See Table 3.

MAINTENANCE

ROUTINE VISUAL INSPECTION

A properly installed PM-5MPX detector system is highly resistant to blinding by contamination build-up on the detector front face window. However, a thick enough build-up will begin to reduce the performance of the detector. This can be prevented by periodically inspecting installed detectors visually for contamination build-up on the detector front face. If such a build-up is observed, it should be removed by cleaning the detector front face window with a soft cloth or lens tissue. The minimum inspection period should be compatible with appropriate regulating agency requirements.

WARNING

To prevent the risk of electrostatic discharge, the surface of the detector should only be cleaned with a damp cloth.

PERIODIC SYSTEM TEST

The authority having jurisdiction and internal facility requirements generally call for routine testing of safety systems at defined intervals, which, at a minimum, should conform to the requirements of NFPA 72. These tests should include visual inspections and the steps listed in the System Test section above.

Table 3—Troubleshooting Guide

Symptom	Probable Cause	Corrective Action
Trouble signal at fire alarm control panel.	Incorrect wiring	Check circuit installation.
	Low or no voltage to detector.	Check voltage of Red or Orange wire with respect to the Black or Brown wire. Should be 9 to 30 Vdc.
	Detector malfunction.	Replace detector
Detector does not alarm during FIRE RESPONSE test with PSS-MP.	Incorrect wiring.	Check circuit installation.
	PSS-MP temperature different from detector.	Allow detector and PSS-MP temperatures to stabilize. Turn on PSS-MP at least 15 seconds prior to test.
	Low batteries in PSS-MP.	Replace batteries and retest.
	Detector malfunction.	Replace detector.
Red LED out.	Incorrect wiring or incorrect power to the detector.	Check circuit installation.
	Detector malfunction.	Replace detector.

WARNING

A full system test results in an alarm output. This will result in the suppression system being activated if it is not disabled prior to testing.

DEVICE REPAIR AND RETURN

The PM-5MPX is completely potted, which does not allow it to be repaired. If a problem should develop, carefully check system wiring and ensure that power is applied to the device. If it is determined that the problem is caused by a detector failure, the PM-5MPX must be replaced.

ORDERING INFORMATION

When ordering, please specify:

PM-5MPX Dual Spectrum® Infrared Flame Detector

For assistance in ordering a system to meet the needs of a specific application, contact:

Detector Electronics Corporation
6901 West 110th Street
Minneapolis, Minnesota 55438 USA
Operator: (952) 941-5665 or (800) 765-FIRE
Customer Service: (952) 946-6491
Fax: (952) 829-8750
Web site: www.det-tronics.com
E-mail: det-tronics@det-tronics.com

APPENDIX A

FM APPROVAL DESCRIPTION AND PERFORMANCE REPORT

HAZARDOUS LOCATION RATINGS

- Intrinsically safe for Class I, II, III, Div. 1, Groups C, D, E, F and G Hazardous (Classified) Locations per FM 3610.
- Non-incendive for Class I, Div. 2, Groups A, B, C and D Hazardous (Classified) Locations per FM 3611.

AUTOMATIC FIRE ALARM SIGNALING PERFORMANCE (FM 3620: 2000)

RESPONSE CHARACTERISTICS

(Typical Response Time < 0.5 Sec.)

Fuel	Size	Distance (feet)
n-Heptane	1 x 1 foot	18
Isopropanol	8 in. dia.	8
Polypropylene	8 in. dia.	8

NOTE: Response time measurements based upon shuttered test method.

FALSE ALARM IMMUNITY

False Alarm Source	Distance (inches)	Modulated Response	Unmodulated Response
Arc welding, Type E6012 rod, 1/8" dia., 1/4" plate	42	No alarm	No alarm
70 W sodium vapor lamp	6	No alarm	No alarm
250 W mercury vapor lamp	12	No alarm	No alarm
300 W incandescent lamp	8	No alarm	No alarm
500 W quartz halogen lamp shielded w/window	30	No alarm	No alarm
1500 W electric quartz heater	108	No alarm	No alarm
Two 34 W fluorescent lamps	<3	No alarm	No alarm

FALSE ALARM IMMUNITY COMBINED WITH FIRE SOURCE

False Alarm Source	False Alarm Source Distance (feet)	Fire Source	Fire Source Distance (inches)
Arc welding, unmodulated	3.5	10 in propane	12
Arc welding, modulated	3.5	10 in propane	12
70 W sodium vapor lamp, unmodulated	0.5	10 in propane	24
70 W sodium vapor lamp, modulated	0.5	10 in propane	19
250 W mercury vapor lamp, unmodulated	1.0	10 in propane	20
250 W mercury vapor lamp, modulated	1.0	10 in propane	20
300 W incandescent lamp, unmodulated	0.67	10 in propane	27
300 W incandescent lamp, modulated	0.67	10 in propane	21
500 W shielded quartz halogen lamp, unmodulated	2.5	10 in propane	25
500 W shielded quartz halogen lamp, modulated	2.5	10 in propane	18
1500 W electric quartz heater, unmodulated	9	10 in propane	24
1500 W electric quartz heater, modulated	9	10 in propane	27
Two 34 W fluorescent lamps, unmodulated	0.25	10 in propane	20
Two 34 W fluorescent lamps, modulated	0.25	10 in propane	24

**FIELD OF VIEW
(Typical Response Time <0.5 Sec.)**

Fuel	Size	Distance (feet)	Vert./Horiz. (degrees)
n-Heptane	1 x 1 foot	9	+55 -55
Isopropanol	8 in. dia.	4	+55 -55
Polypropylene	8 in. dia.	4	+55 -55

NOTE: Response time measurements based upon shuttered test method.

APPENDIX B

CONTROL DRAWING CONFIGURATION

PM-5MPX CONTROL DRAWING CONFIGURATION			
HAZARDOUS (CLASSIFIED) LOCATION	NFPA 72 INITIATING DEVICE CIRCUIT CLASS & STYLE	INSTALLATION TYPE	CONTROL DWG NO.
CLASS I, DIV. 1, GROUPS C & D	CLASS B, STYLE B	INTRINSICALLY SAFE	420032
CLASS II, DIV. 1, GROUPS E, F & G	CLASS B, STYLE B	INTRINSICALLY SAFE	420032
CLASS I, DIV. 2, GROUPS A, B, C & D	CLASS B, STYLE B	INTRINSICALLY SAFE	420032
CLASS II, DIV. 2, GROUPS F & G	CLASS B, STYLE B	INTRINSICALLY SAFE	420032
CLASS III, DIV. 2	CLASS B, STYLE B	INTRINSICALLY SAFE	420032
CLASS I, DIV. 2, GROUPS A, B, C & D	CLASS B, STYLE B	NON-INCENDIVE	420033
CLASS II, DIV. 2, GROUPS F & G	CLASS B, STYLE B	NON-INCENDIVE	420033
CLASS III, DIV. 2	CLASS B, STYLE B	NON-INCENDIVE	420033
NON-HAZARDOUS (UNCLASSIFIED)	CLASS B, STYLE B	NON-INCENDIVE	420033
CLASS I, DIV. 2, GROUPS A, B, C & D	CLASS A, STYLE D	NON-INCENDIVE	420034
CLASS II, DIV. 2, GROUPS F & G	CLASS A, STYLE D	NON-INCENDIVE	420034
CLASS III, DIV. 2	CLASS A, STYLE D	NON-INCENDIVE	420034
NON-HAZARDOUS (UNCLASSIFIED)	CLASS A, STYLE D	NON-INCENDIVE	420034

Figure B1—Control Drawing Configuration (Drawing No. 420031)

HAZARDOUS LOCATIONS:
 CLASS I, DIV. 1, GP. C, D
 CLASS II, DIV. 1, GP. E, F, G
 CLASS III, DIV. 2

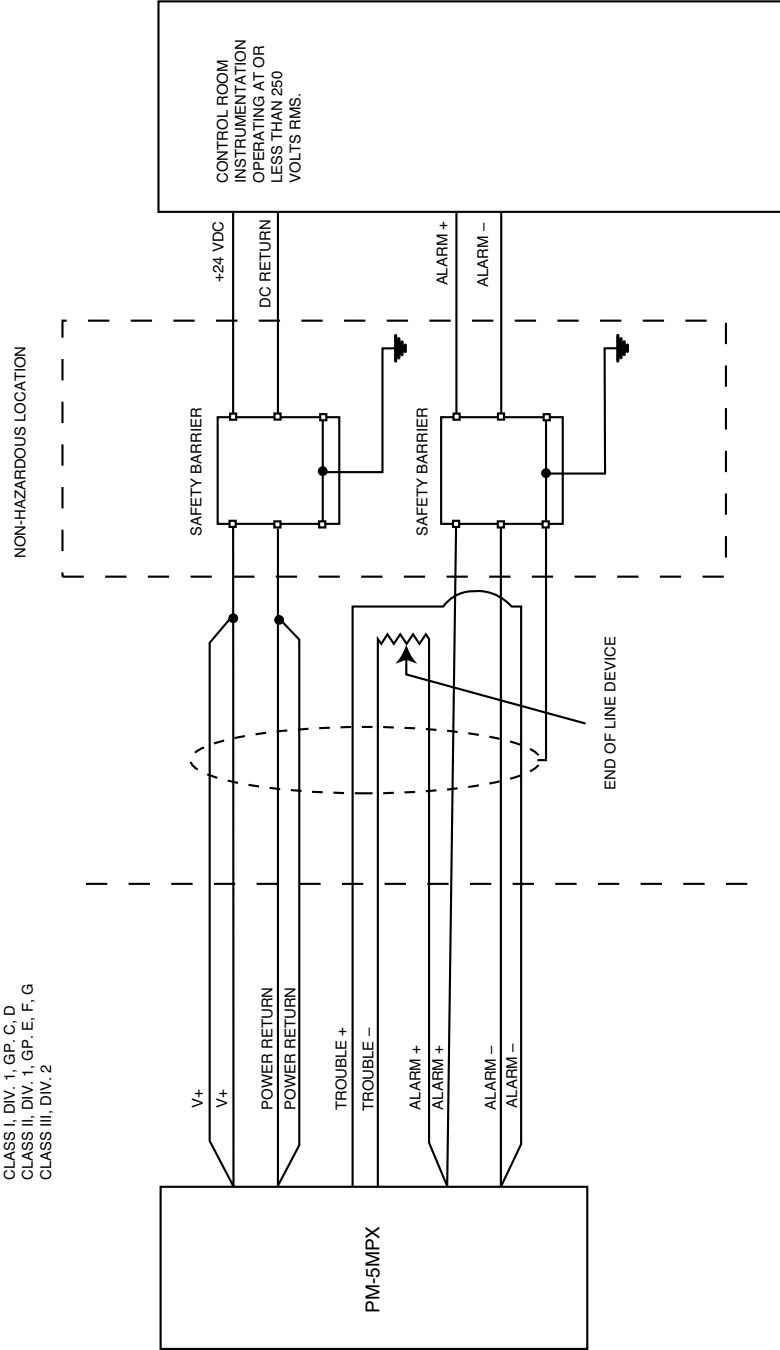

NOTES:

- SUITABLE FOR INTRINSICALLY SAFE INSTALLATION IN CLASS I, DIV. 1, GP. C, D; CLASS I, DIV. 2, GP. A, B, C, D; CLASS II, DIV. 1, GP. E, F & G; CLASS II, DIV. 2, GP. F & G. CLASS III, DIV. 2 HAZARDOUS LOCATIONS. WIRING METHODS SHALL BE INSTALLED IN ACCORDANCE WITH ANS/NFPA 70 (NEC), ANS/NFPA 72 AND ISA RP 12.6.
- I. S. BARRIERS MUST BE INSTALLED IN ACCORDANCE WITH THE MANUFACTURER'S GUIDELINES.
- THIS DRAWING SHOWS ONE SENSOR CONNECTED IN A CLASS B, STYLE B CONFIGURATION PER NFPA 72. MULTIPLE SENSORS MAY NOT BE CONNECTED TO THE SAME BARRIER. AN END OF LINE DEVICE (EOL) IS REQUIRED TO MONITOR LINE CONTINUITY.
- END OF LINE DEVICE VALUE PLUS BARRIER RESISTANCE MUST PROVIDE ADEQUATE SUPERVISION CURRENT FOR FIRE ALARM CONTROL PANEL.
- RESISTANCE BETWEEN BARRIER GROUND AND EARTH GROUND MUST NOT EXCEED ONE OHM.
- PM-5MPX INTERCONNECTS VIA FLYING LEAD. EXTENSION CABLE SHALL COMPLY WITH ANS/NFPA 70 (NEC) ARTICLE 504-30(b)(2).
- CABLE SHIELD MUST BE TIED TO INTRINSIC SAFETY GROUND AT THE BARRIER.
- THE PM-5MPX SENSOR HAS BEEN SYSTEM APPROVED WITH THE FIM APPROVED BARRIERS LISTED IN THE BARRIER TABLE.
- MAXIMUM CABLE LENGTH: 1000 FEET.

Figure C1—Intrinsically Safe Class B, Style B Wiring (Drawing No. 420032)

APPENDIX C

INTRINSICALLY SAFE CLASS B, STYLE B WIRING

Hazardous (Classified) Locations:
 Class I, Division 1, Group C, D
 Class I, Division 2, Group A, B, C, D
 Class II, Division 1, Group E, F, G
 Class II, Division 2, Group F, G
 Class III, Division 2

PM-5MPX ELECTRICAL INTERFACE	
Wire Color	Signal
Red	V+, Input Power
Orange	V+, Input Power
Black	Power Return
Brown	Power Return
Yellow	Alarm +
Green	Alarm +
Blue	Alarm -
Violet	Alarm -
Gray	Trouble +
White	Trouble -

BARRIER TABLE

MODEL	MANUFACTURER	BARRIER PARAMETERS	
		Vt (V)	It (mA)
900277-280-094-00	STAHL	28.1	87.0
Z978	PEPPERL + FUCHS	30.0	93.0
7278ac	MTL	28.0	94.0

HAZARDOUS LOCATION:
 CLASS I, DIV. 2, GROUPS A, B, C & D.
 CLASS II, DIV. 2, GROUPS F & G.
 CLASS III, DIV. 1 & 2.

NON-HAZARDOUS LOCATION

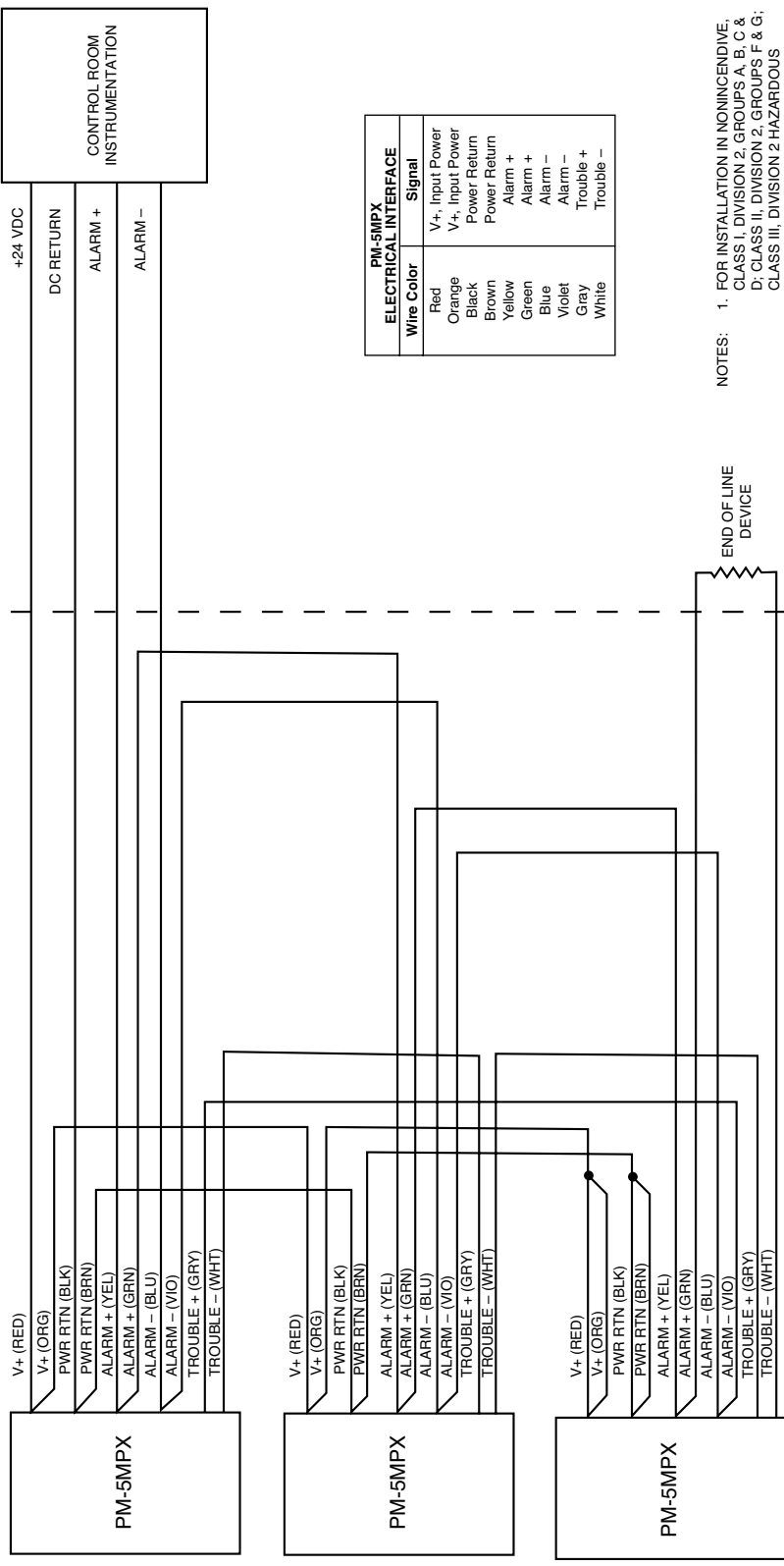

PM-5MPX ELECTRICAL INTERFACE	
Wire Color	Signal
Red	V+, Input Power
Orange	V+, Input Power
Black	Power Return
Brown	Power Return
Yellow	Alarm +
Green	Alarm +
Blue	Alarm -
Violet	Alarm -
Gray	Trouble +
White	Trouble -

NOTES: 1. FOR INSTALLATION IN NONINCENDIVE, CLASS I, DIVISION 2, GROUPS A, B, C & D; CLASS II, DIVISION 2, GROUPS F & G; CLASS III, DIVISION 2 HAZARDOUS (CLASSIFIED) LOCATIONS, OR NON-HAZARDOUS LOCATIONS ONLY. WIRING METHODS SHALL BE INSTALLED IN ACCORDANCE WITH ANS/NFPA 70 (NEC) ARTICLE 501-4(b) AND ANS/NFPA 72.

- THIS DRAWING SHOWS THREE SENSORS CONNECTED IN ONE ZONE IN A CLASS B, STYLE B CONFIGURATION PER NFPA 72. ADDITIONAL SENSORS CAN BE ADDED BY REPEATING THE WIRING PATTERN OF THE CENTRAL SENSOR.
- PM-5MPX INTERCONNECTS VIA FLYING LEAD.
- ELECTRICAL REQUIREMENT: 9 TO 30 VDC AND 10 MILLIAMPS (MAX) PER SENSOR.
- AN END OF LINE DEVICE, AS REQUIRED BY THE FIRE ALARM CONTROL PANEL, IS USED TO MONITOR LINE CONTINUITY.

Figure D1—Non-Incendive Class B, Style B Wiring (Drawing No. 420033)

APPENDIX D
NONINCENDIVE
CLASS B, STYLE B WIRING
 Hazardous (Classified) Locations:
 Class I, Division 2, Group A, B, C, D
 Class II, Division 2, Group F, G
 Class III, Division 2
 Non-hazardous (Non-classified) Locations

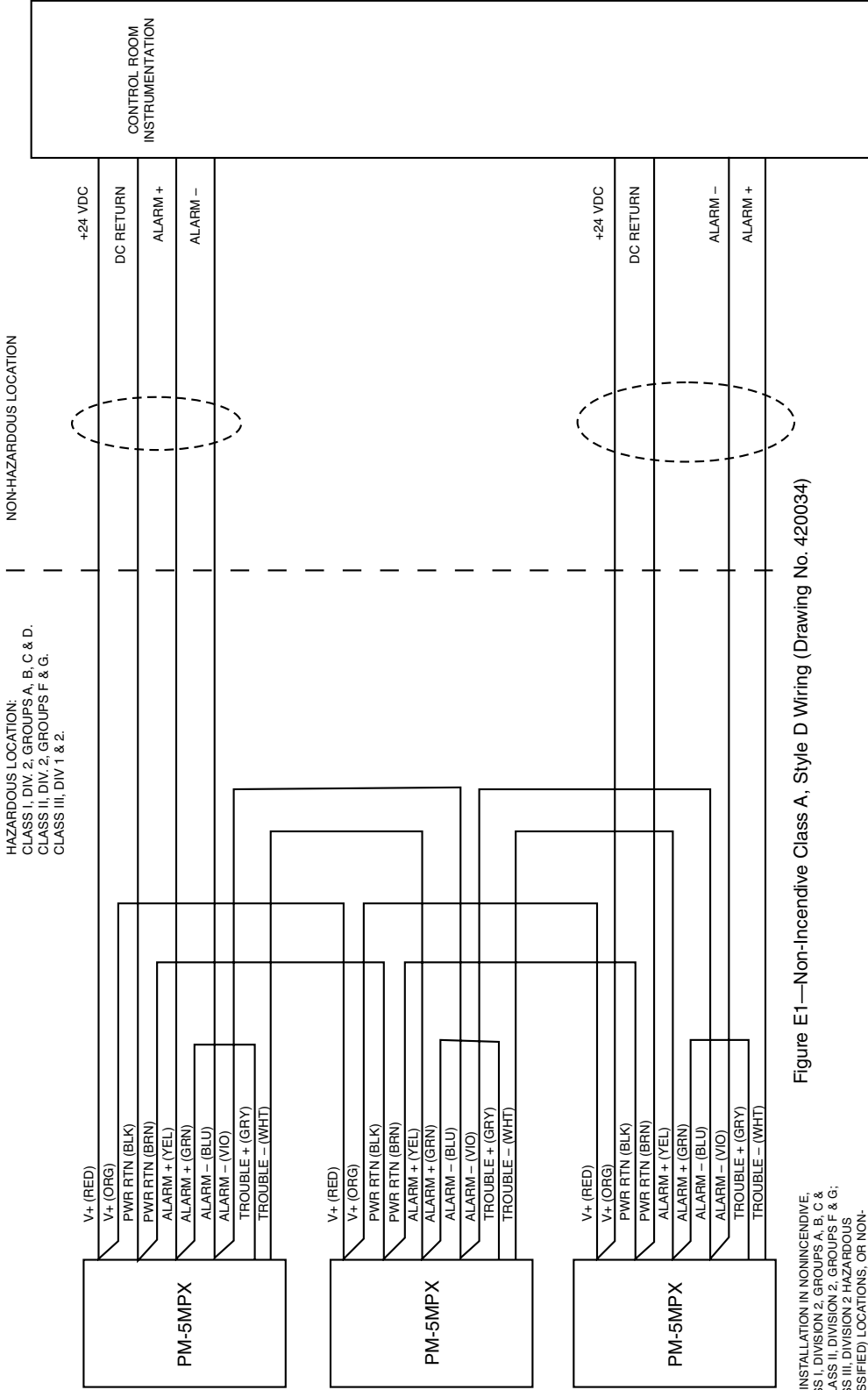

Figure E1—Non-Incendive Class A, Style D Wiring (Drawing No. 420034)

- NOTES:
- FOR INSTALLATION IN NONINCENDIVE, CLASS I, DIVISION 2, GROUPS A, B, C & D; CLASS II, DIVISION 2, GROUPS F & G; CLASS III, DIVISION 2 HAZARDOUS (CLASSIFIED) LOCATIONS, OR NON-HAZARDOUS LOCATIONS ONLY. WIRING METHODS SHALL BE INSTALLED IN ACCORDANCE WITH ANS/NFPA 70 (NEC) ARTICLE 501-4(b) AND ANS/NFPA 72.
 - THIS DRAWING SHOWS THREE SENSORS CONNECTED IN ONE ZONE IN A CLASS A, STYLE D CONFIGURATION PER NFPA 72. ADDITIONAL SENSORS CAN BE ADDED BY REPEATING THE WIRING PATTERN OF THE CENTRAL SENSOR.
 - PM-5MPX INTERCONNECTS VIA FLYING LEAD.
 - ELECTRICAL REQUIREMENT: 9 TO 30 VDC AND 10 MILLIAMPS (MAX) PER SENSOR.
 - THE OUTGOING AND RETURN (REDUNDANT) CIRCUIT CONDUCTORS SHALL NOT BE RUN IN THE SAME CABLE ASSEMBLY, ENCLOSURE, OR RACEWAY PER NFPA 72.

PM-5MPX ELECTRICAL INTERFACE	
Wire Color	Signal
Red	V+, Input Power
Orange	V+, Input Power
Black	Power Return
Brown	Power Return
Yellow	Alarm +
Green	Alarm +
Blue	Alarm -
Violet	Alarm -
Gray	Trouble +
White	Trouble -

APPENDIX E

NON-INCENDIVE CLASS A, STYLE D WIRING

Hazardous (Classified) Locations:
 Class I, Division 2, Group A, B, C, D
 Class II, Division 2, Group F, G
 Class III, Division 2

Non-hazardous (Non-classified) Locations

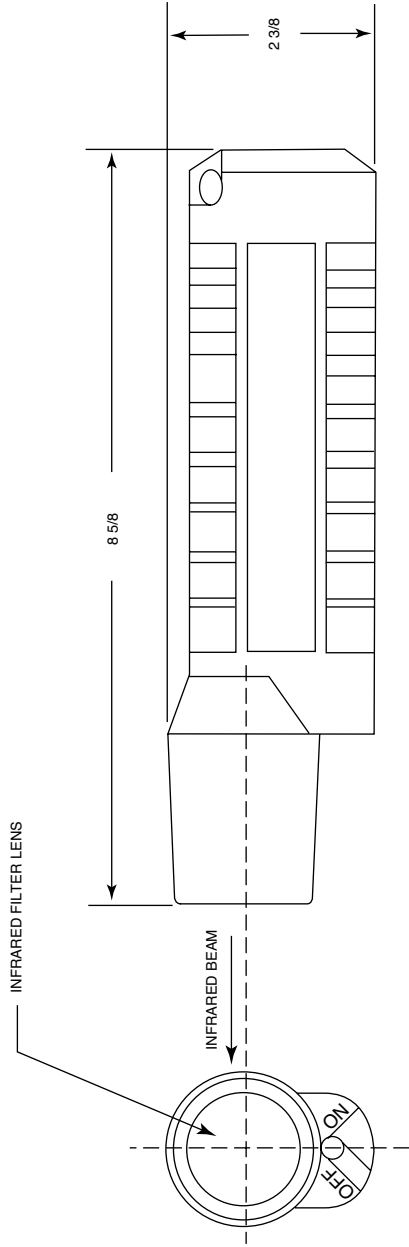
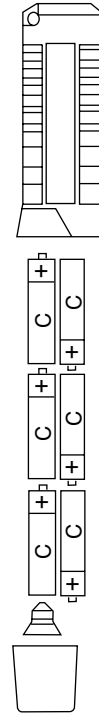

Figure F1—PSS-MP Test Lamp



- LAMP REPLACEMENT**
 REPLACE XENON LAMP MODULE WITH PN 18801 (UNDERWATER KINETICS).
- WARNING**
 THIS UNIT IS NOT RATED FOR USE IN HAZARDOUS (CLASSIFIED) LOCATIONS.
- CAUTION**
 A FULL SYSTEM TEST RESULTS IN AN ALARM OUTPUT. THIS WILL RESULT IN THE AUTOMATIC SUPPRESSION SYSTEM BEING ACTIVATED IF IT IS NOT DISABLED PRIOR TO TESTING.
- OPERATION**
 TURN ON PSS-MP WAIT 15 SECONDS. TO CAUSE AN ALARM, HOLD PSS-MP SO THAT THE INFRARED FILTER LENS IS LESS THAN 1 INCH FROM THE FRONT OF THE FLAME DETECTOR TO BE TESTED. IT CAN TAKE SEVERAL SECONDS FOR THE DETECTOR TO ALARM.
- NOTE**
 FOR VALID TEST RESULTS, THE TEST LAMP AND THE SENSOR UNDER TEST MUST BE AT APPROXIMATELY THE SAME TEMPERATURE.
- BATTERY REPLACEMENT**
 THE TEST LAMP REQUIRES 6 ALKALINE C-SIZE BATTERIES.
- WARNING**
 CHANGE BATTERY IN NON-HAZARDOUS LOCATION ONLY.

APPENDIX F
PSS-MP TEST LAMP



95-8562



X3301 Multispectrum
IR Flame Detector



PointWatch Eclipse®
IR Combustible Gas Detector



FlexVu® Universal Display
w/ GT3000 Toxic Gas Detector



Eagle Quantum Premier®
Safety System

Detector Electronics Corporation
6901 West 110th Street
Minneapolis, MN 55438 USA

T: 952.941.5665 or 800.765.3473
F: 952.829.8750

W: <http://www.det-tronics.com>
E: det-tronics@det-tronics.com



Det-Tronics and  (Optical Integrity) are registered trademarks or trademarks of Detector Electronics Corporation in the United States, other countries, or both. Other company, product, or service names may be trademarks or service marks of others.

© Copyright Detector Electronics Corporation 2013. All rights reserved